

**BIDANG PENDIDIKAN DAN PENGAJARAN**  
**BERITA ACARA PERKULIAHAN**  
**KULIAN ONLINE(*E-LEARNING*)**

**PERIODE SEMESTER GENAP 2021-2022**

MATA KULIAH:

**DASAR SISTEM KENDALI**  
**KLAS A**

*LAMPIRAN BERITA ACARA PERKULIAHAN :*

- 1. SK.DEKAN FTI SEMESTER GENAP 2021/2022*
- 2. PRESENSI KEHADIRAN DOSEN DAN MATERI AJAR*
- 3. CONTOH HAND OUT MATERI AJAR*
- 4. NILAI KOMULATIF; KEHADIRAN,TUGAS, UTS DAN UAS*

**PROGRAM STUDI TEKNIK ELEKTRO**  
**FAKULTAS TEKNOLOGI INDUSTRI**  
**INSTITUT SAINS DAN TEKNOLOGI NASIONAL**



YAYASAN PERGURUAN CIKINI  
INSTITUT SAINS DAN TEKNOLOGI NASIONAL

Jl. Moh. Kahfi II, Bhumi Srengseng Indah, Jagakarsa, Jakarta Selatan 12640  
Telp. 021-7270090 (hunting), Fax. 021-7866955, hp: 081291030024  
Email : humas@istn.ac.id Website : www.istn.ac.id

**SURAT PENUGASAN TENAGA PENDIDIK**

Nomor : 141/03.1 – G / III / 2022

SEMESTER **GENAP** , TAHUN AKADEMIK 2021 / 2022

Nama	: Edy Supriyadi, H., Ir. MT.	Status Pegawai	: Edukatif Tetap / Tidak Tetap			
NIK	: 22870030	Program Studi	: Teknik Elektro			
Jabatan Akademik	: Lektor Kepala					
Bidang	Perincian Kegiatan	Tempat	Jam / Minggu	Kredit (sks)	Keterangan	
<b>I PENDIDIKAN Dan PENGAJARAN</b>	<b>MENGAJAR DI KELAS ( KULIAH / RESPONSI DAN LABORATORIUM )</b>					
	1. Dasar Sistem Kendali ( Klas A)			2	Senin, 08:00-09:40	
	2. Sistem Kendali Digital ( Klas A)			3	Senin, 10:30-12:10	
	3. Elektronika Terpadu (D.III Klas A)			2	Senin, 15:00-16:40	
	4. Dasar Elektronika ( Klas A)			2	Selasa, 13:00-14.40	
	5. Dasar Elektronika ( Klas K)			2	Rabu, 17.30-19.00	
	6. Sistem Kendali Waktu Nyata ( Klas A)			3	Kamis, 13.00-14.40	
	7. Dasar Sistem Kendali ( Klas K)			2	Kamis, 17.00-18.40	
	8.				-	
	9.				-	
	10.				-	
	11.				-	
	12.				-	
	13.				-	
	14.				-	
	15.				-	
	16.				-	
	17. Membimbing Skripsi / Tugas Akhir					
18. Menguji Skripsi / Tugas Akhir				1		
<b>II PENELITIAN</b>	1. Penelitian Ilmiah					
	2. Penulisan Karya Ilmiah			1		
	3. Penulisan Diktat Kuliah					
	4. Menerjemahkan Buku					
	5. Pembuatan Rancangan Teknologi					
	6. Pembuatan Rancangan & Karya Pertunjukan					
<b>III PENGABDIAN DAN MASYARAKAT</b>	1. Menduduki Jabatan di Pemerintahan					
	2. Pengembangan Hasil Pendidikan Dan Penelitian					
	3. Memberikan Penyuluhan/Pelatihan/Ceramah pada masyarakat				1	
	4. Memberikan Pelayanan Kepada Masyarakat Umum					
	5. Menulis Karya Pengabdian Pada Masyarakat yang tidak dipublikasikan					
	6. Komersial / Kesepakatan					
<b>IV UNSUR-UNSUR PENUNJANG</b>	1. Jabatan Struktural					
	2. Penasehat Akademik					
	3. Berperan serta aktif dalam pertemuan ilmiah / seminar				1	
	4. Pengembangan program kuliah / Kelompok Ilmu Elektro					
	5. Menjadi anggota panitia / Badan pada suatu Perguruan Tinggi					
	6. Menjadi anggota Badan Lembaga Pemerintahan					
	7. Menjadi Anggota Organisasi Profesi					
	8. Mewakili PT / Lembaga Pemerintah duduk dalam Panitia antar Lembaga					
	9. Menjadi Anggota Delegasi Nasional ke Parlemen – Parlemen Internasional					
Jumlah Total				20		
Kepada yang bersangkutan akan diberikan gaji / honorarium sesuai dengan peraturan penggajian yang berlaku di Institut Sains dan Teknologi Nasional Penugasan ini berlaku dari tanggal <b>21 Maret 2022</b> sampai dengan tanggal <b>31 Agustus 2022</b> .						



( Dr. Musfirah Cahya F.T.S.Si., M.Si.)

**Tembusan :**

1. Direktur Akademik - ISTN
2. Direktur Non Akademik - ISTN
3. Ka. Biro Sumber Daya Manusia - ISTN
4. Kepala Program Studi Fak. ....
5. Arsip



**Berita Acara Perkuliahan**  
**(Presentasi Kehadiran Dosen)**  
**SEMESTER GENAP TAHUN AKADEMIK 2021/2022**  
**PROGRAM STUDI TEKNIK ELEKTRO S1 FTI - ISTN**

Nama Dosen		: 1. Ir. Edy Supriyadi, MT. 2. Ir. Abdul Muis, MT.			Hari		: Senin
Mata Kuliah		: Dasar Sistem Kendali			Jam		: 08.00-09.40
Kelas		: A			Ruang		:
No.	Hari / Tanggal	Materi Pembelajaran	Metode Belajar	Jml Mhs	Paraf Dosen		
1.	Senin / 21-03-2022	Pendahuluan; Orientasi mata kuliah Das Sistem Kendali, penjelasan system penilaian	Google Meet	5			
2.	Senin / 28-03-2022	Pengenalan Das Sistem Kendali; Defenisi-defenisi, macam macam klasifikasi S Pengaturan dan beberapa aplikasinya + Tugas 1	elearning istn dan Google Meet	5			
3.	Senin / 04-04-2022	Analisa Gambar Dengan Diagram Blok + Tugas 2	elearning istn dan Google Meet	5			
4.	Senin / 11-04-2022	Analisa Gambar Dengan Grafik Aliran + Tugas 3	elearning istn dan Google Meet	5			
5.	Senin / 18-04-2022	Analisa Matematis Dengan Transformasi Laplace + Tugas 4	elearning istn dan Google Meet	5			
6.	Senin / 25-04-2022	Analisa Matematis Dengan Inversed T Lapalace + Tugas 5	elearning istn dan Google Meet	5			
7.	Senin / 09-05-2022	Review dan Diskusi Tugas 1 sampai dengan Tugas 5	elearning istn dan Google Meet	5			
8.	Senin / 16-05-2022	UJIAN TENGAH SEMESTER (UTS) SEMESTER GENAP 2021/2022	elearning istn dan Google Meet	5			



**Berita Acara Perkuliahan**  
**(Presentasi Kehadiran Dosen)**  
**SEMESTER GENAP TAHUN AKADEMIK 2021/2022**  
**PROGRAM STUDI TEKNIK ELEKTRO S1 FTI - ISTN**

Nama Dosen		: 1. Ir. Edy Supriyadi, MT. 2. Ir. Abdul Muis, MT.			Hari		: Senin
Mata Kuliah		: Dasar Sistem Kendali			Jam		: 08.00-09.40
Kelas		: A			Ruang		:
No.	Hari / Tanggal	Materi Pembelajaran	Metode Belajar	Jml Mhs	Paraf Dosen		
9	Senin / 23-05-22	Pemodelan Matematis Sistem 1 + Tugas 6	elearning istn dan Google Meet	5			
10	Senin / 30-05-22	Pemodelan Matematis Sistem 2 + Tugas 7	elearning istn dan Google Meet	5			
11	Senin / 06-06-22	Tanggapan Waktu Sistem Orde 1	elearning istn dan Google Meet	5			
12	Senin / 13-06-22	Tanggapan Waktu Sistem Orde 2 + Tugas 8	elearning istn dan Google Meet	5			
13	Senin / 20-06-22	Kestabilan sistem 1_ + Tugas 9	elearning istn dan Google Meet	5			
14	Senin / 27-06-22	Kestabilan sistem 2 Tugas 10	elearning istn dan Google Meet	5			
15	Senin / 04-07-22	Review dan Diskusi Tugas 6 sampai dengan Tugas 10	elearning istn dan Google Meet	5			
16	Senin / 11-07-22	UJIAN AKHIR SEMESTER GENAP 2122	elearning istn dan Google Meet	5			

Mengetahui  
 Kepala Program Studi

**Ir. Harlan Effendi, MT** )

# Pendahuluan

---

Sistem Kendali  
Teknik Kendali  
Dasar Sistem Kendali

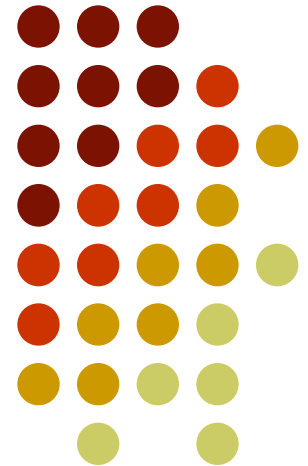



- Apakah Definisi Sistem itu ya ....?



# SISTEM MOBIL



Komponen-komponen Mobil



# SISTEM pesawat TV

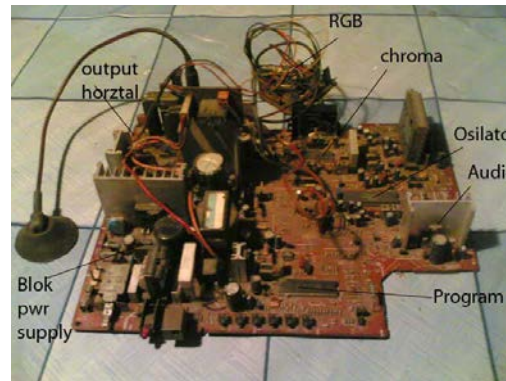
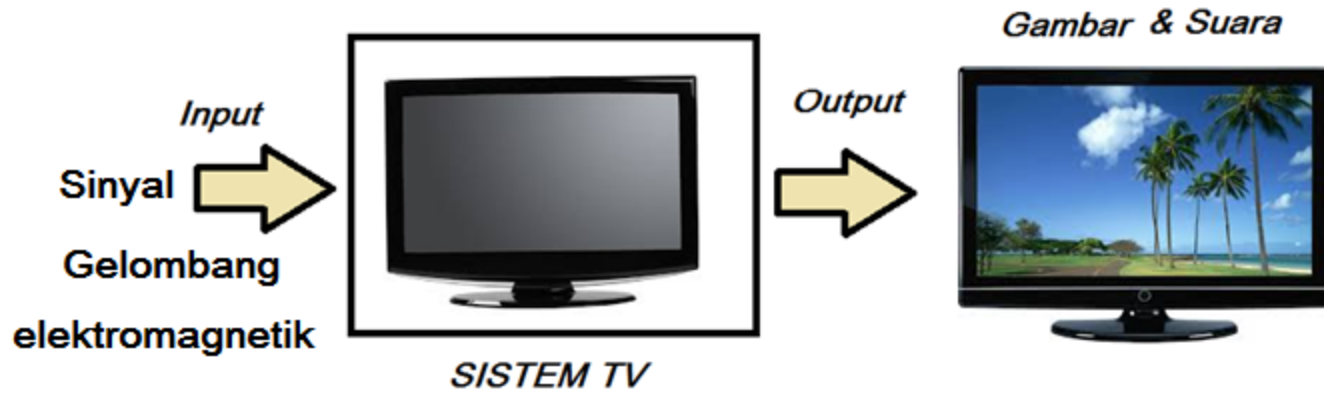

Komponen-komponen TV



# Sistem PLTU Batu bara



# Komponen PLTU

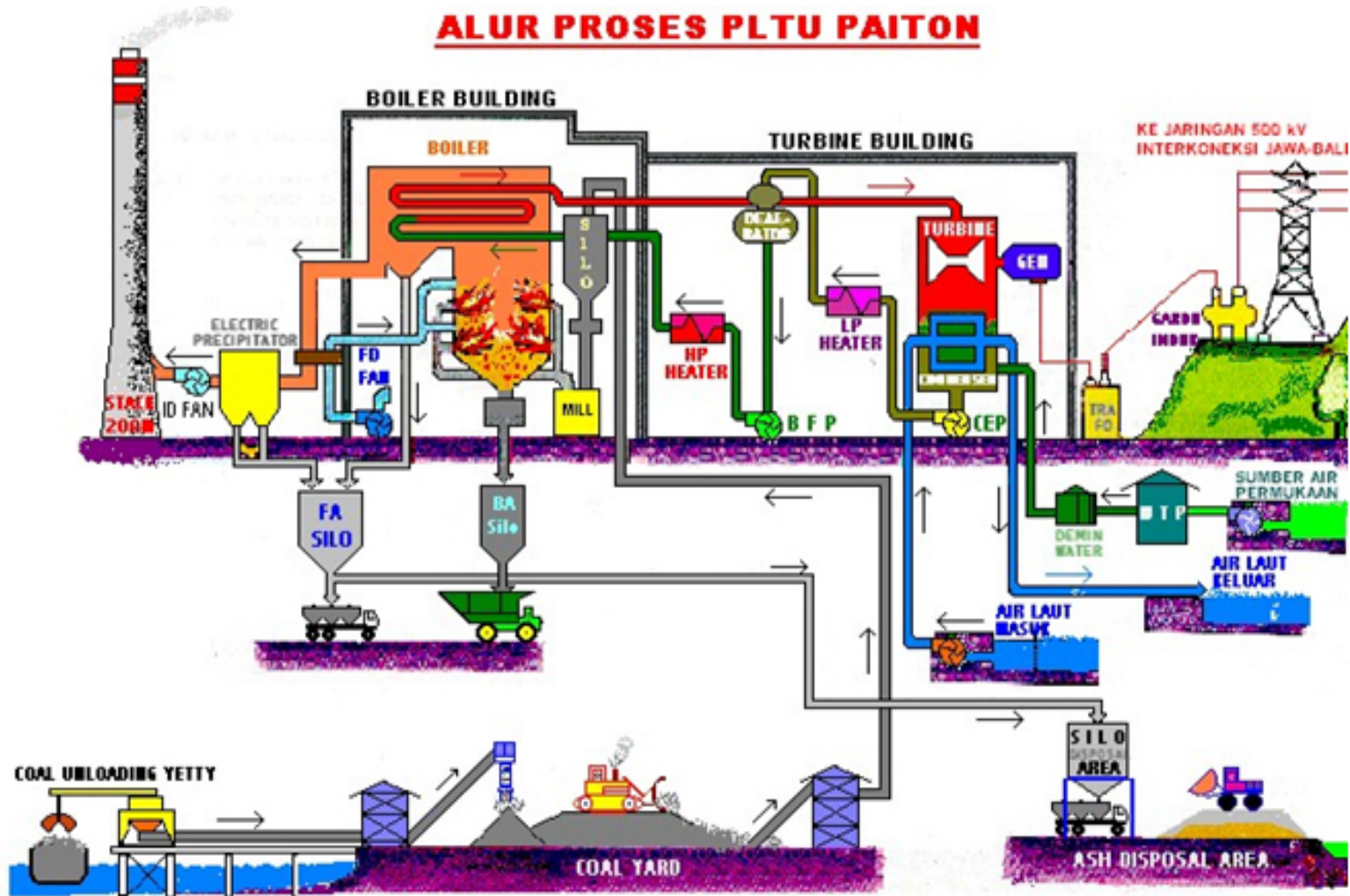



# Definisi Sistem

- Sistem merupakan sekelompok komponen – komponen yang saling bekerjasama satu sama lain untuk melakukan suatu proses sedemikian rupa agar target / sasaran yang hendak dicapai terpenuhi

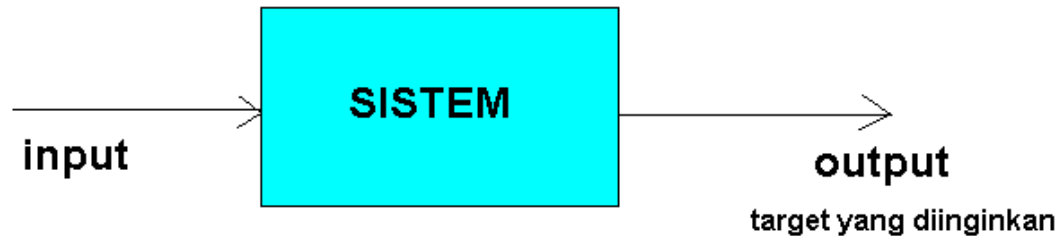



- Apakah Sistem Kendali Itu ?



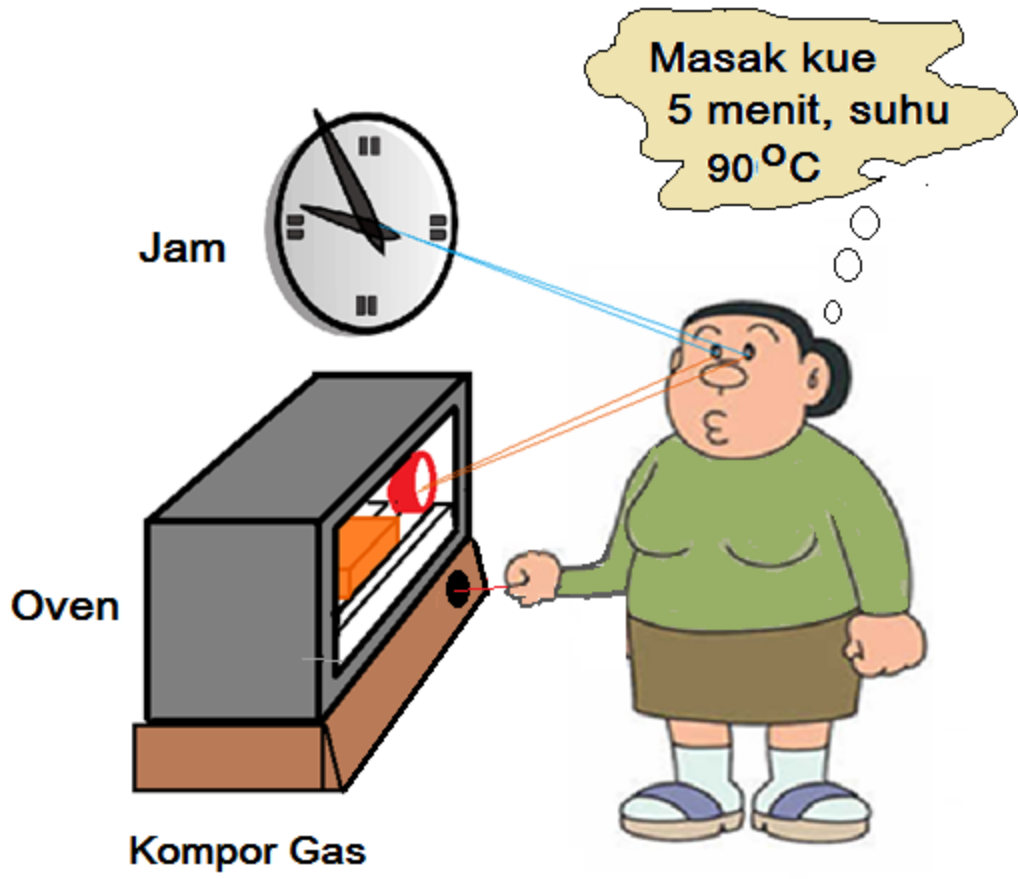



## Diagram blok sistem kendali manual Oven

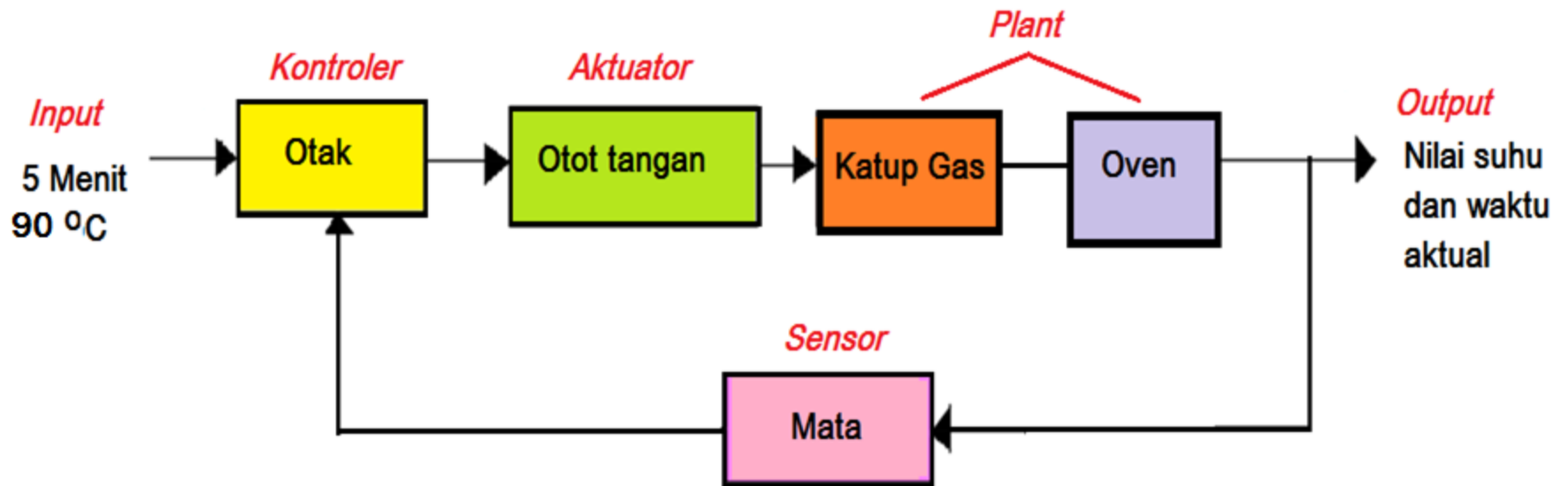



# Sistem kendali otomatis oven listrik

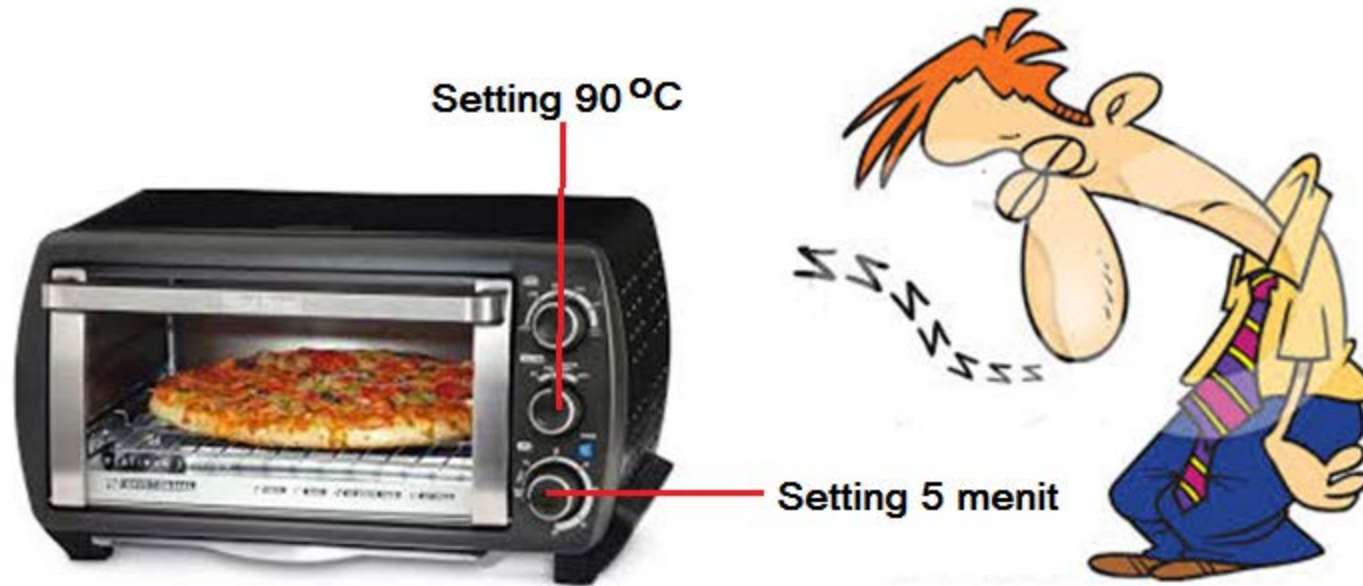



# Sistem kendali otomatis oven listrik

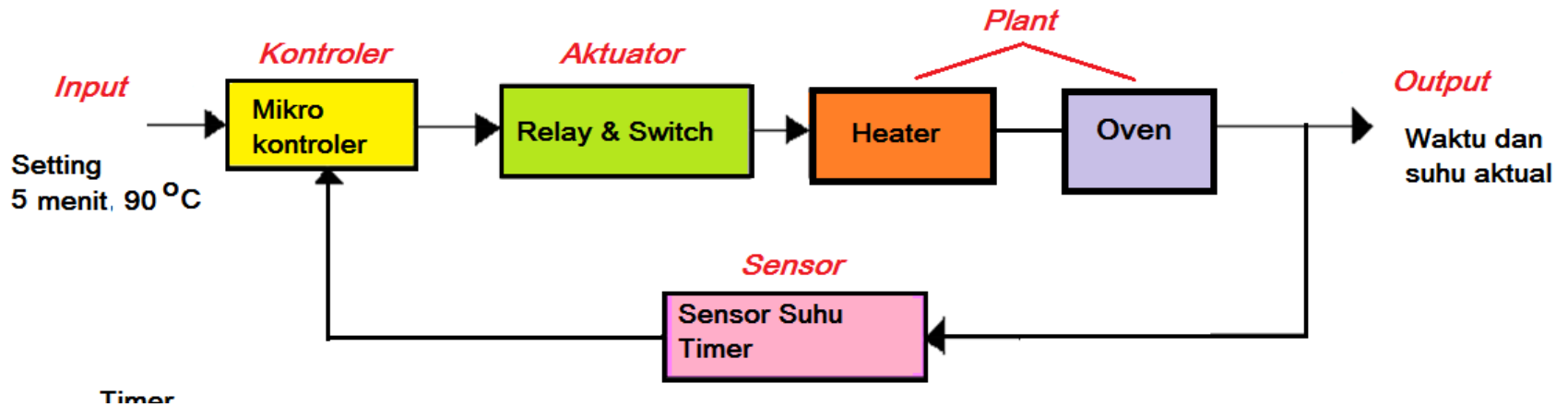



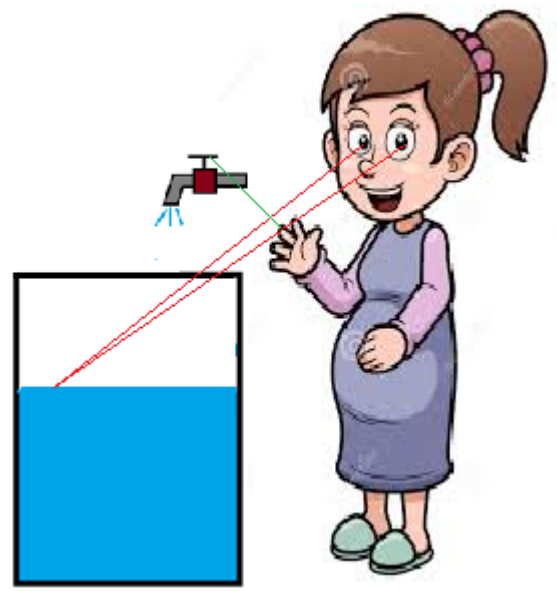
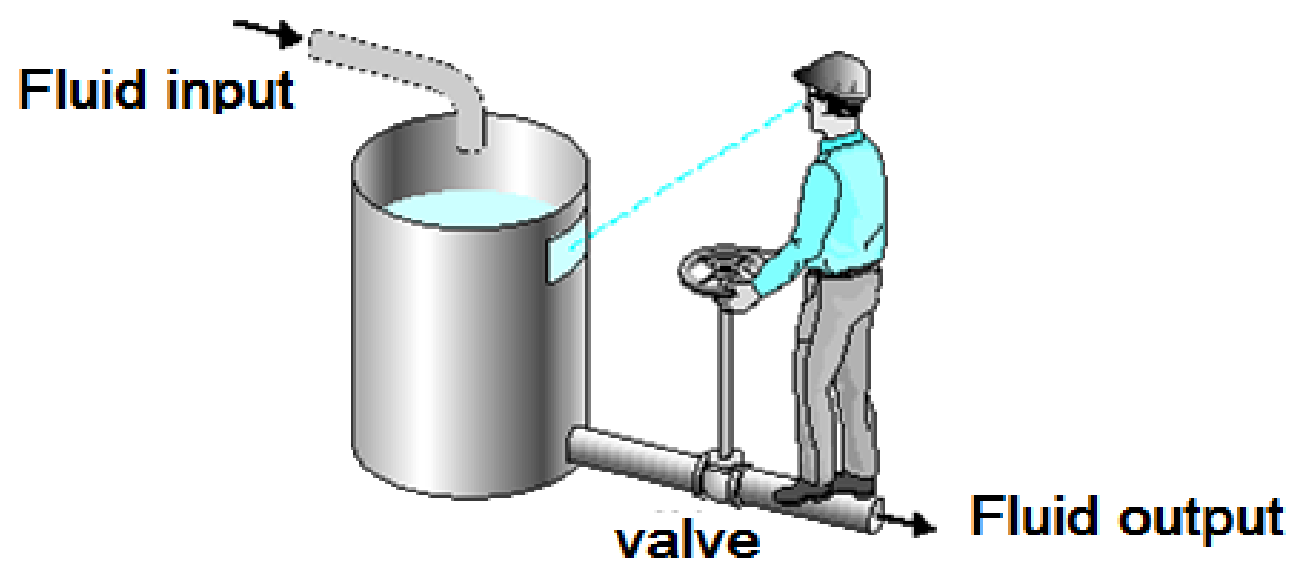

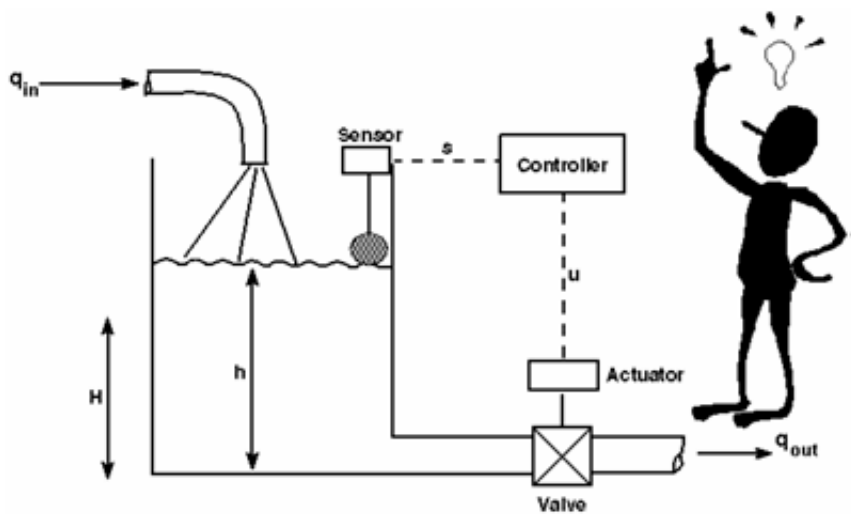



# Definisi Sistem Kendali

- Sistem Kendali adalah suatu sistem yang bertujuan untuk mengendalikan suatu proses pada sistem agar output (keluaran) sistem yang dihasilkan dapat dikendalikan sedemikian rupa sehingga tidak terjadi kesalahan. Dalam hal ini output yang dikendalikan adalah kestabilannya, ketelitian, dan kedinamisannya

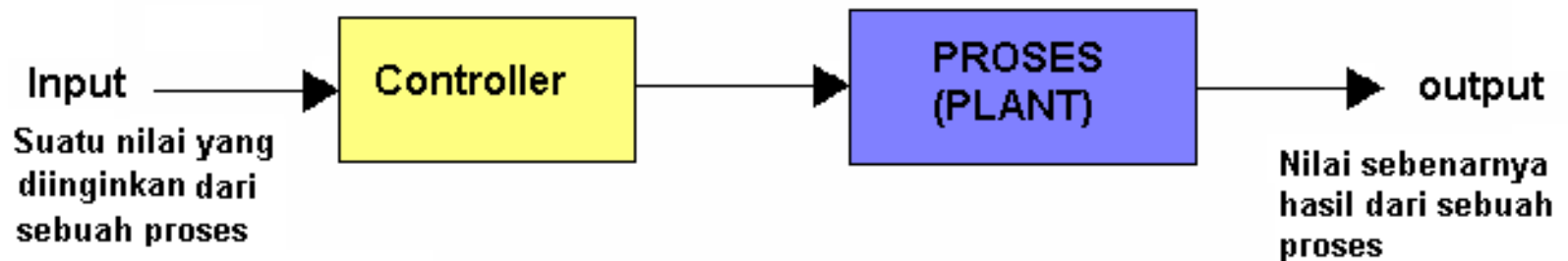

# Sistem kendali pada tangki air

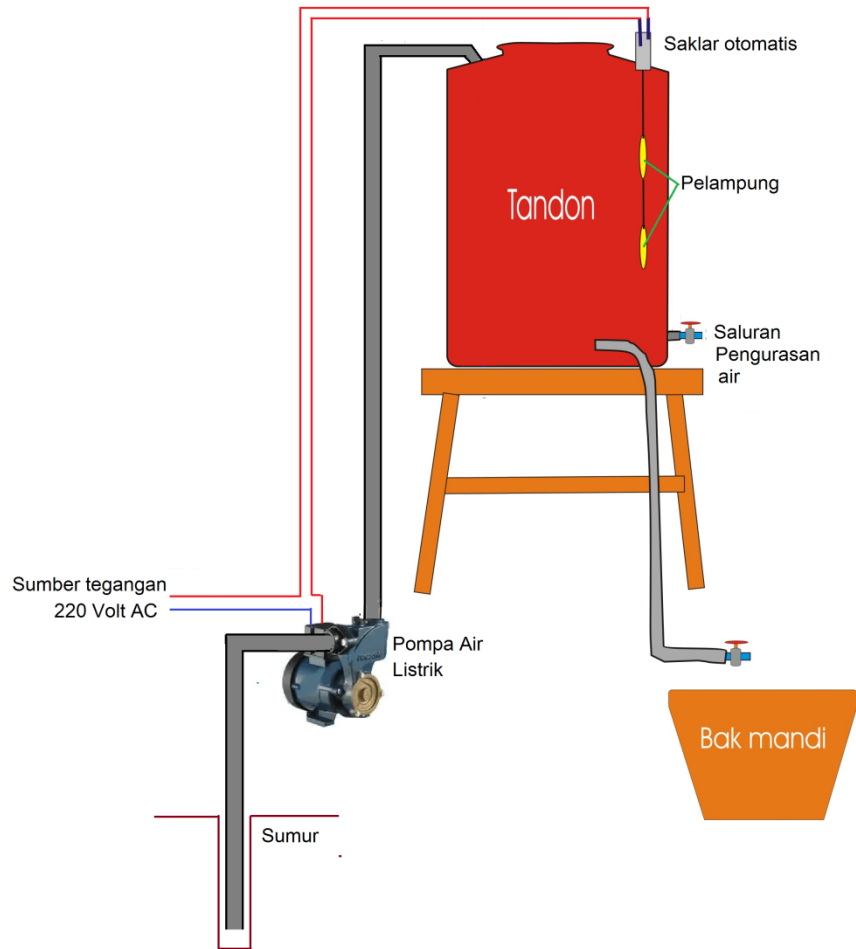

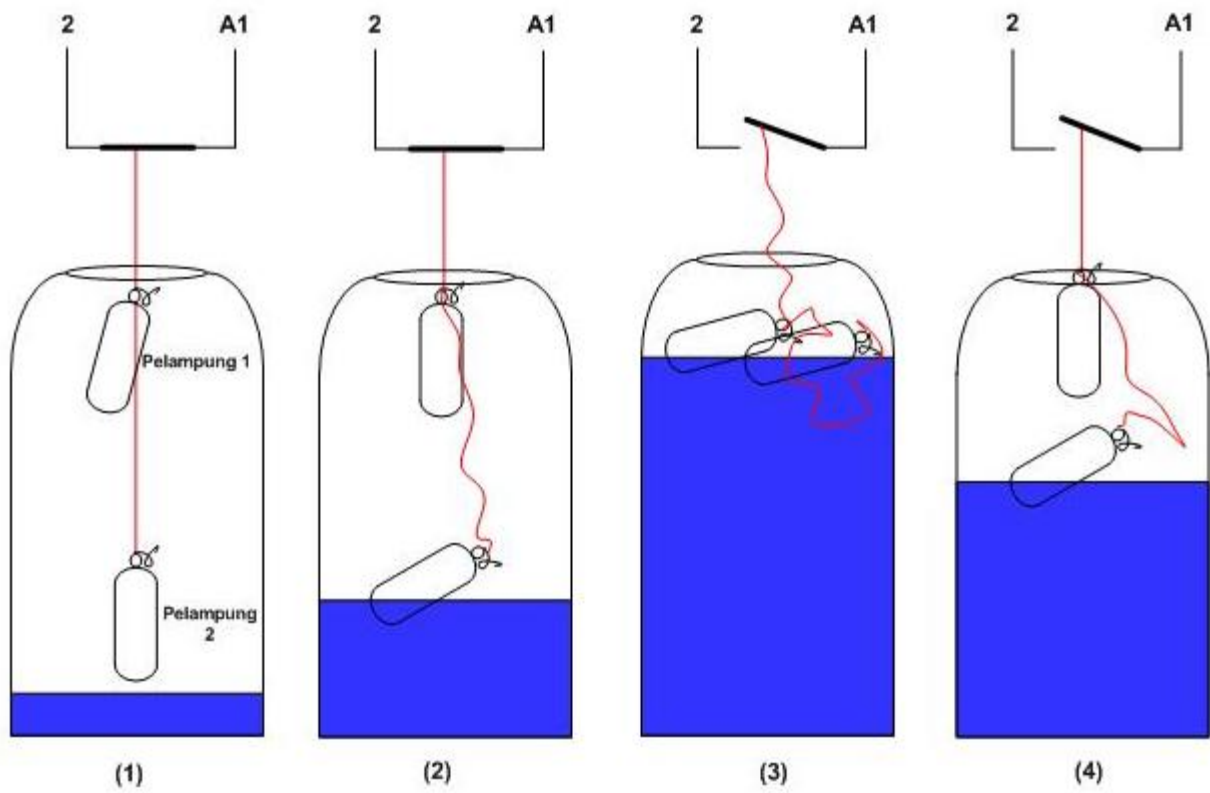



# Diagram blok sistem kendali tandon air

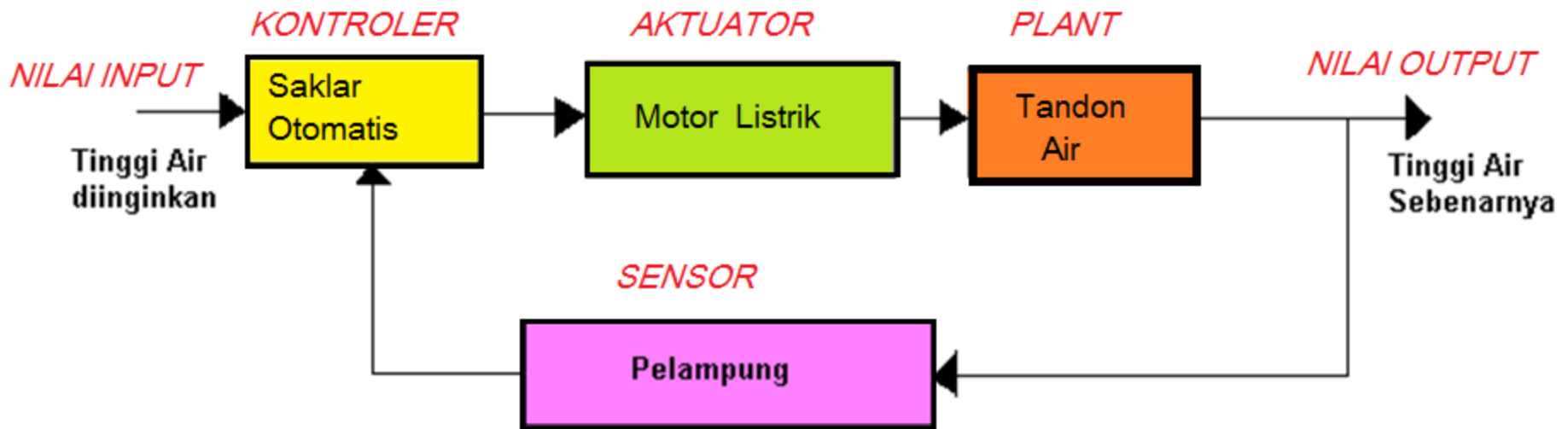

Sistem kendali terdiri atas sekelompok komponen-komponen yang saling bekerjasama satu sama lainnya secara berurutan untuk mengendalikan suatu proses (plant) agar output sistem sesuai dengan yang dikehendaki

# Pintu otomatis



# Pintu otomatis

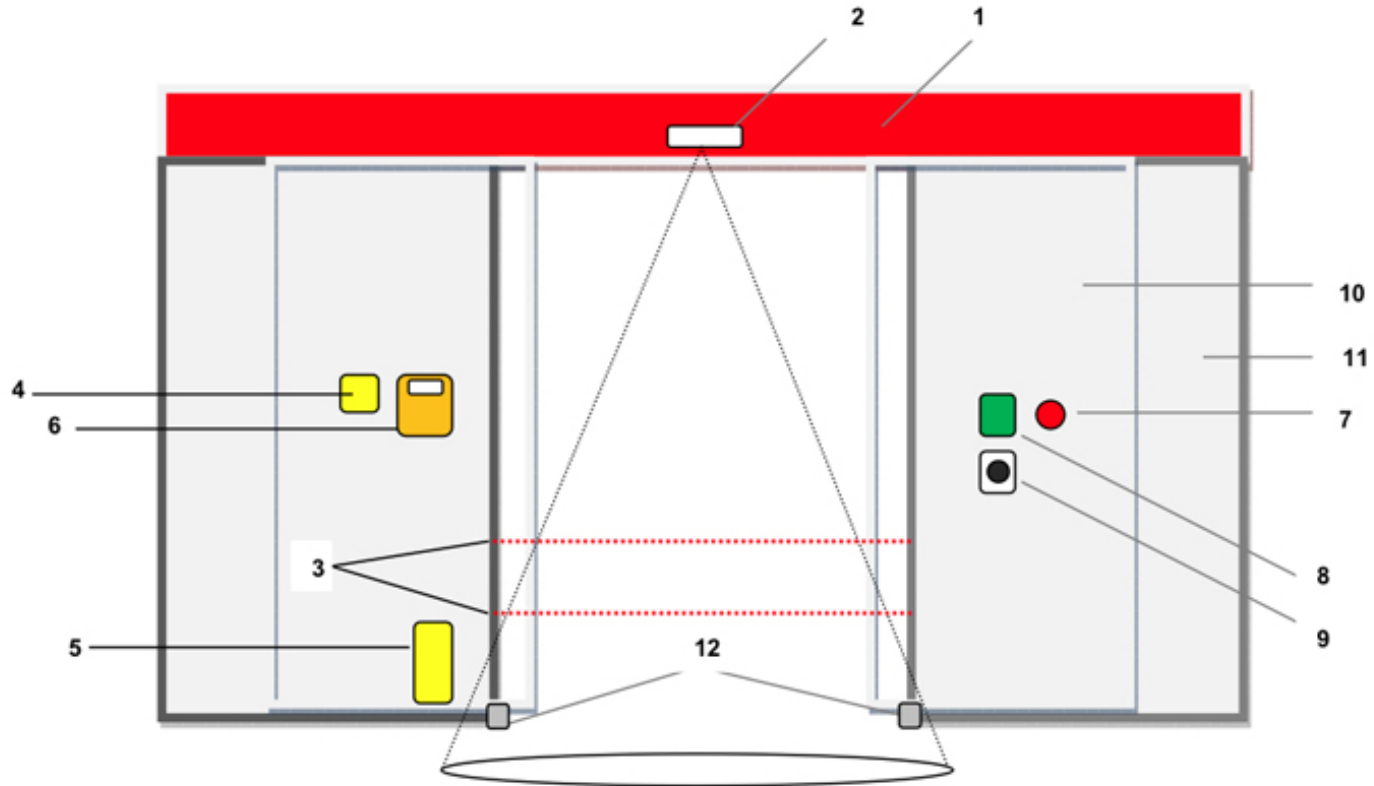
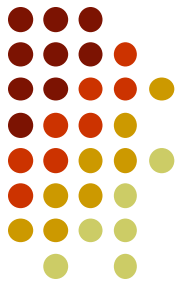

## Parts and accessories

- |  |                           |
|--|---------------------------|
| 1. Operator cover                          | 7. Emergency-stop button  |
| 2. Overhead radar/ overhead safety sensor  | 8. Emergency break glass  |
| 3. Safety beam sensor                      | 9. 4 positions key switch |
| 4. Press switch                            | 10. Sliding door leaf     |
| 5. Kick switch                             | 11. Fix panel             |
| 6. Card access system/ other access system | 12. Floor guide           |



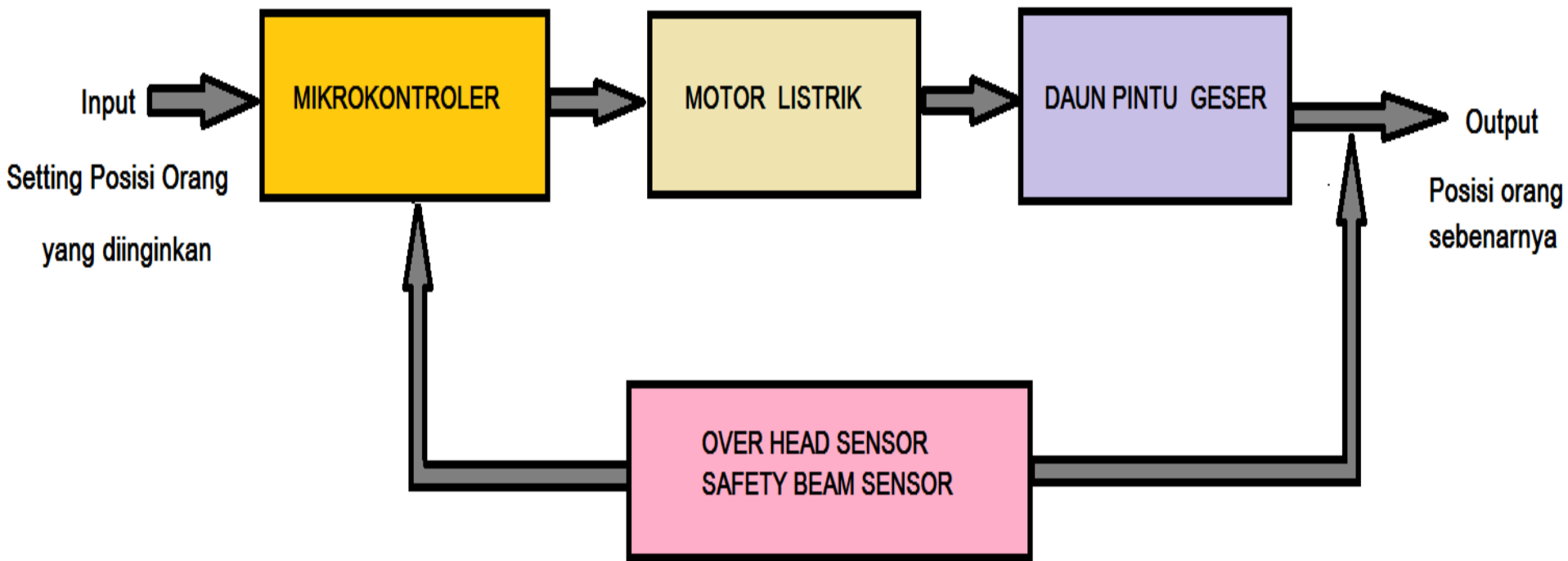

# Sistem kendali pada lift



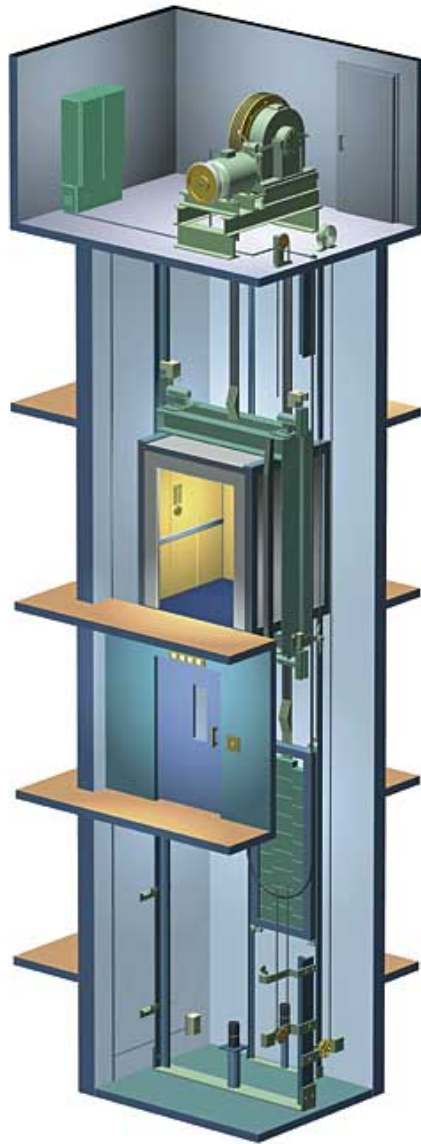

**Kontruksi LIFT  
(Plant)**

## **Komponen - komponen Sistem kendali pada lift**

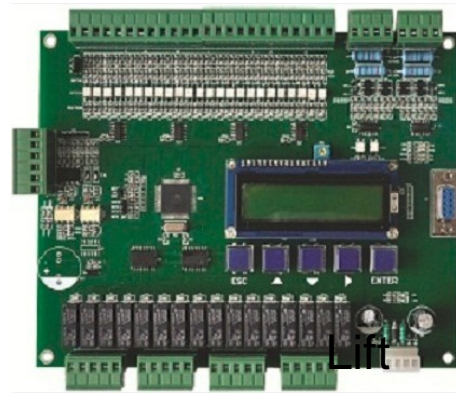

**Rangkaian kontrol motor  
( Controller )**

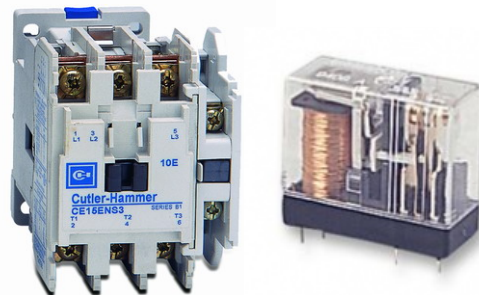

**conractor, rele  
(aktuator)**



**Motor Listrik  
(Bagian dari Plant  
yang dikendalikan)**



**Box Panel Control**

# Sensor – sensor Lift

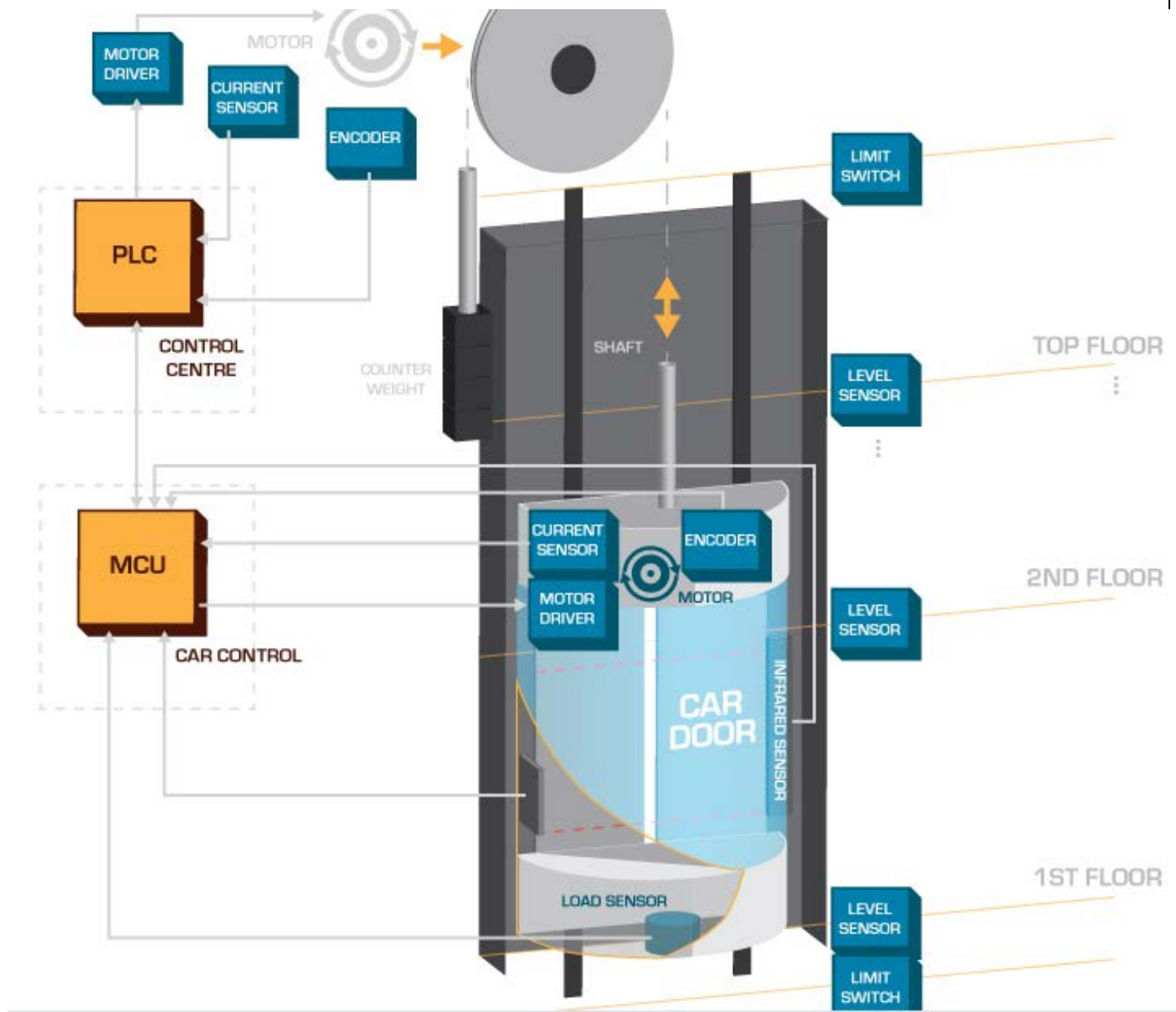

# Sistem kendali Pada Lift

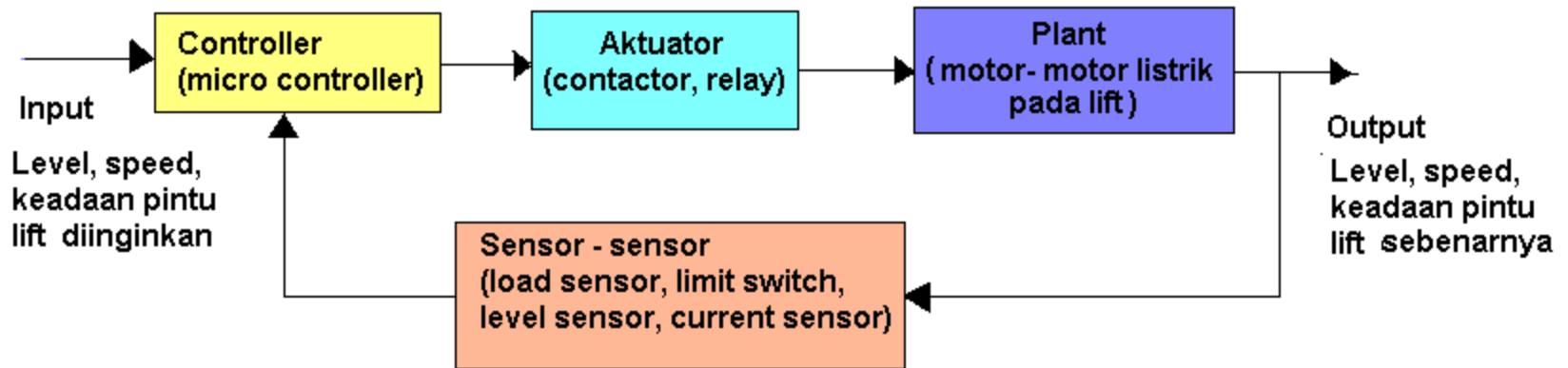

# Definisi PLANT

- Plant adalah seperangkat peralatan yang mungkin terdiri dari beberapa mesin yang saling bekerja sama yang digunakan untuk operasi tertentu. Beberapa contoh plant misalnya heater, reaktor kimia, mesin pemrosesan industri, boiler, dan sebagainya.

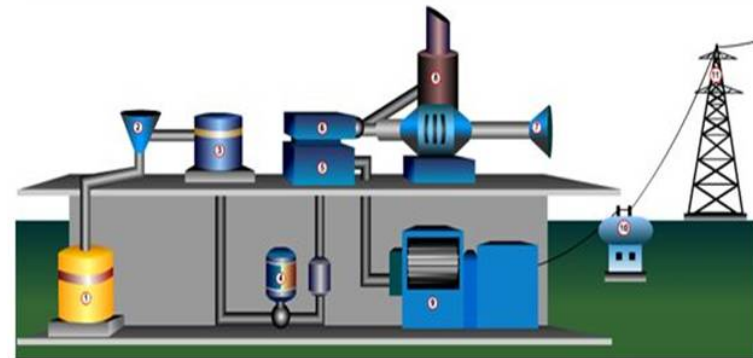

# Sistem Kendali AC

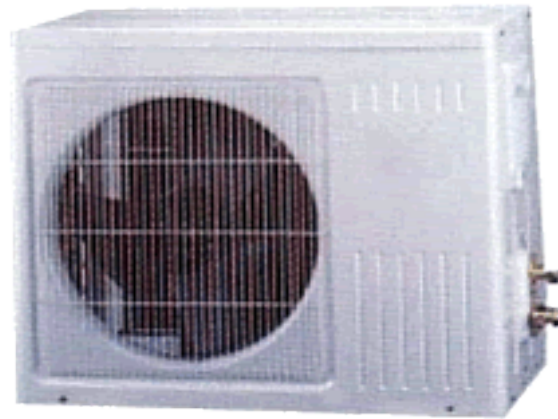

# Sistem Air Conditioner

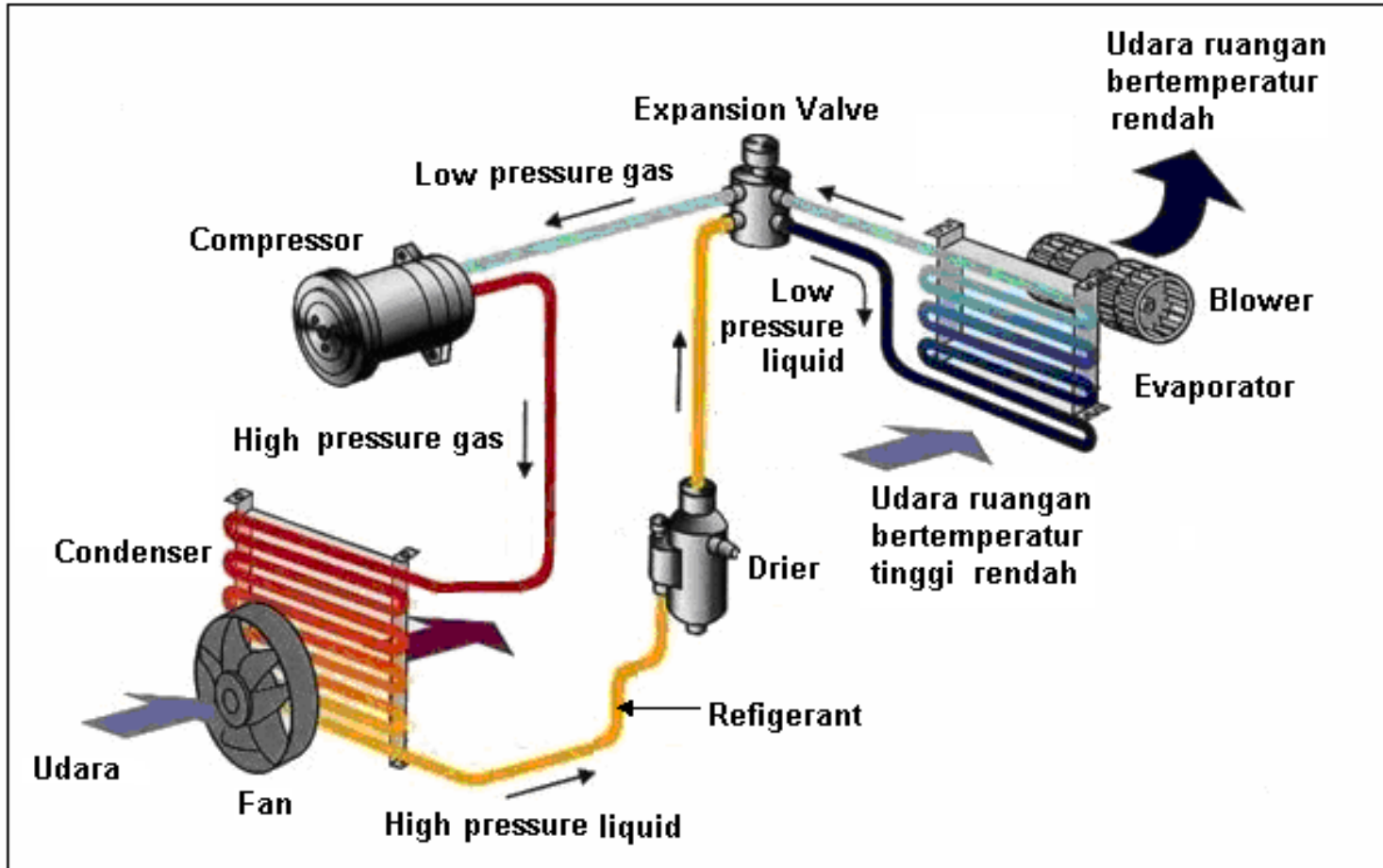



# Sistem kendali AC Spilt

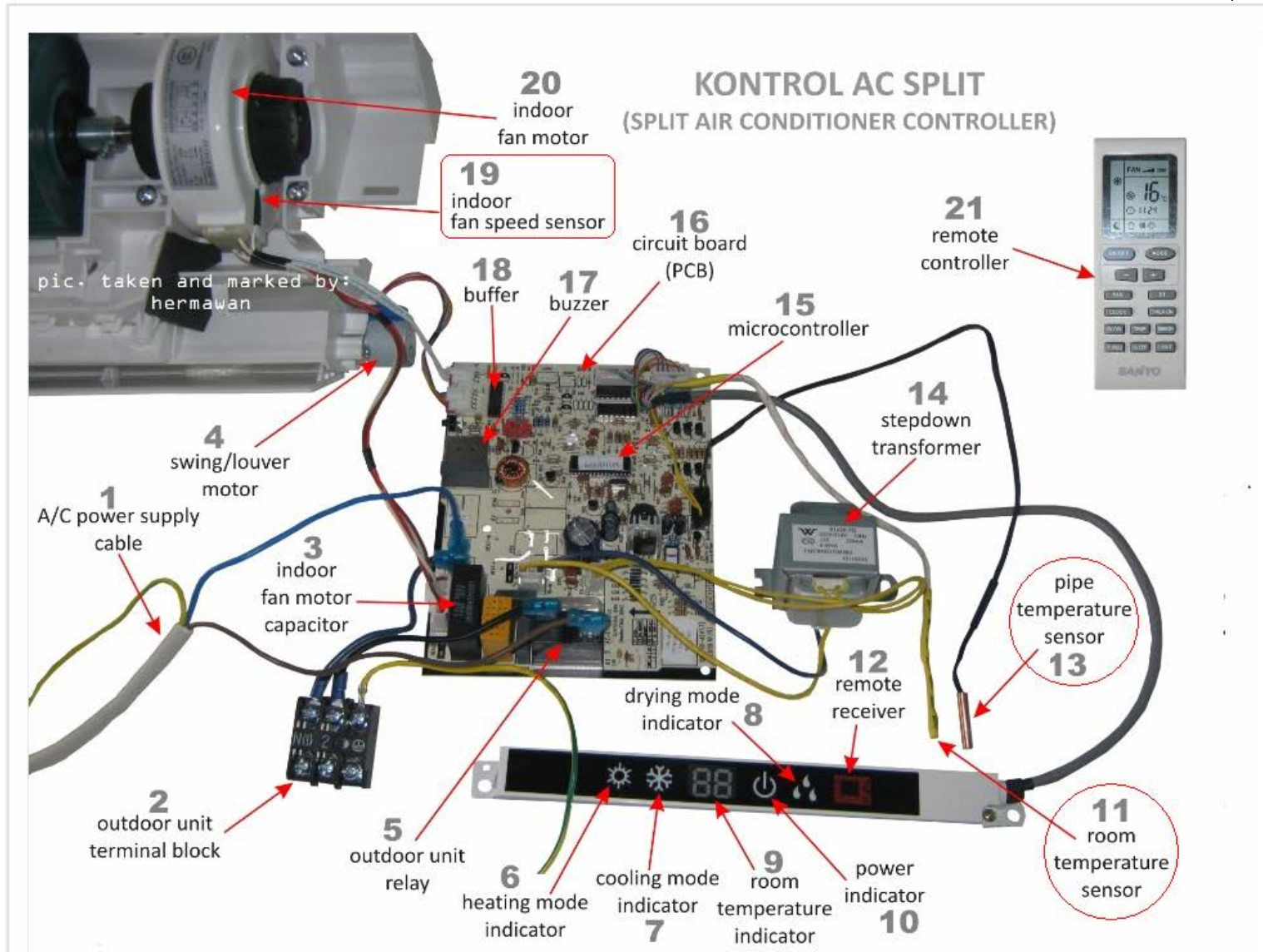



# Blok Diagram Sistem kendali AC

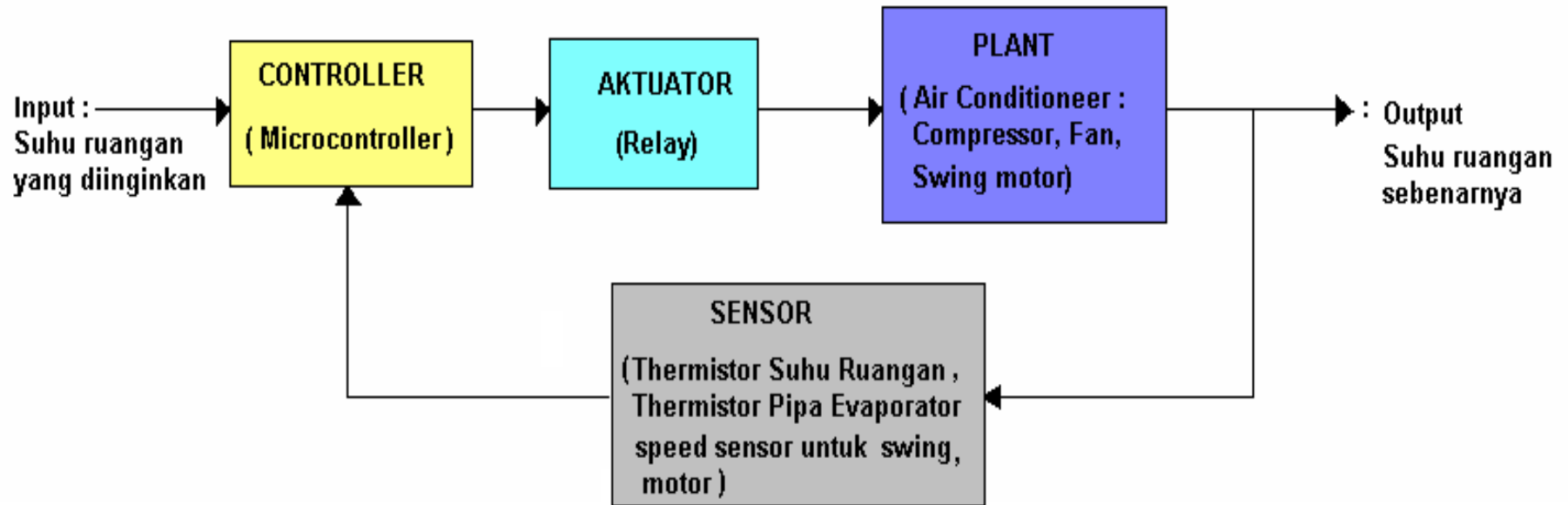

**DAFTAR NILAI**  
**SEMESTER GENAP REGULER TAHUN 2021/2022**

Program Studi : Teknik Elektro S1  
Matakuliah : Dasar Sistem Kendali  
Kelas / Peserta : A  
Perkuliahan : Kampus ISTN Bumi Srengseng Indah  
Dosen : Eddy Supriyadi, Ir. MT.  
Abdul Muis, Ir. MT.

Hal. 1/1

No	NIM	N A M A	ABSEN	TUGAS	UTS	UAS	MODEL	PRESENTASI	NA	HURUF
			10%	20%	30%	40%	0%	0%		
1	16220039	Muhammad Luthfi Imani	38	0	0	0	0	0	0	
2	18220005	Syafrudin	100	75	65	60	0	0	68.5	<b>B</b>
3	19220001	Muhammad Isra Maulana	38	0	0	0	0	0	0	
4	20220001	Muhammad Agung Rahmansyah	69	60	80	60	0	0	66.9	<b>B-</b>
5	20220004	Muhammad Rafly Juliansyah	81	70	50	65	0	0	63.1	<b>C+</b>
6	20220007	Fazryan Dwicahya	100	80	90	80	0	0	85	<b>A</b>
7	20220009	Abyan Syafiq Andana Putra	100	80	80	90	0	0	86	<b>A</b>

Rekapitulasi Nilai							
A	2	B+	0	C+	1	D+	0
A-	0	B	1	C	0	D	0
		B-	1	C-	0	E	0

Jakarta, 29 July 2022

Dosen Pengajar 1

**Eddy Supriyadi, Ir. MT.**

Dosen Pengajar 2

**Abdul Muis, Ir. MT.**