

**BIDANG PENDIDIKAN DAN PENGAJARAN**  
**BERITA ACARA PERKULIAHAN**  
**KULIAH ONLINE/OFF LINE**  
**(LEARNING)**

**PERIODE SEMESTER GENAP 2022-2023**

**MATA KULIAH**

**MESIN-MESIN LISTRIK**

*LAMPIRAN BERITA ACARA PERKULIAHAN*

- 1. SK DEKAN FTI SEMESTER GANJIL 2022-2023*
- 2. PRESENSI KEHADIRAN DOSEN DAN MATERI AJAR*
- 3. CONTOH HAND OUT MATERI AJAR*
- 4. NILAI KOMULATIF : KEHADIRAN, TUGAS, UTS DAN UAS*

**PROGRAM STUDI TEKNIK ELEKTRO**  
**FAKULTAS TEKNOLOGI INDUSTRI**  
**INSTITUT SAINS DAN TEKNOLOGI NASIONAL**



YAYASAN PERGURUAN CIKINI  
INSTITUT SAINS DAN TEKNOLOGI NASIONAL

Jl. Moh. Kahfi II, Bhumi Srengseng Indah, Jagakarsa, Jakarta Selatan 12640  
Telp. 021-7270090 (hunting), Fax. 021-7866955, hp: 081291030024  
Email : humas@istn.ac.id Website : www.istn.ac.id

SURAT PENUGASAN TENAGA PENDIDIK

Nomor : 164/03.1 - G / III / 2023

SEMESTER GENAP, TAHUN AKADEMIK 2022 / 2023

Nama	: Sugianto,Ir,MT	Status Pegawai	: Edukatif Tetap / Tidak Tetap		
NIK	: 186489	Program Studi	: Teknik Elektro		
Jabatan Akademik	: Lektor				
Bidang	Perincian Kegiatan	Tempat	Jam/ Minggu	Kinerja (sks)	Keterangan
I PENDIDIKAN Dan PENGAJARAN	MENGAJAR DI KELAS ( KULIAH / RESPONSI DAN LABORATORIUM )				
	1.Elektronika Daya ( Kls A )			2	Kamis,08.00-14.40
	2.Elektronika Daya ( Kls K )			2	Sabtu ,13.00-14.40
	3.Mesin- Mesin Listrik ( Kls A )			3	Rabu, 10.00-12.30
	4.Mesin- Mesin Listrik ( Kls K )			3	Jumat,17.00-18.40
	5.Ekonomi Teknik ( Kls A )			2	Kamis,13.00-14.40
	6.				
	7.				
	8.				
	9.				
	10.				
	11.				
	12.				
	13.				
	14.				
	15.				
	16.				
	17. Membimbing Skripsi / Tugas Akhir				1
18. Menguji Skripsi / Tugas Akhir				1	
II PENELITIAN	1. Penelitian Ilmiah				
	2. Penulisan Karya Ilmiah				
	3. Penulisan Diktat Kuliah				
	4. Menerjemahkan Buku				
	5. Pembuatan Rancangan Teknologi				
	6. Pembuatan Rancangan & Karya Pertunjukan				
III PENGABDIAN DAN MASYARAKAT	1. Menduduki Jabatan di Pemerintahan				
	2. Pengembangan Hasil Pendidikan Dan Penelitian				
	3. Memberikan Penyuluhan/Pelatihan/Ceramah pada masyarakat				1
	4. Memberikan Pelayanan Kepada Masyarakat Umum				1
	5. Menulis Karya Pengabdian Pada Masyarakat yang tidak dipublikasikan				
	6. Komersial / Kesepakatan				
IV UNSUR-UNSUR PENUNJANG	1. Jabatan Struktural				
	2. Penasehat Akademik				
	3. Berperan serta aktif dalam pertemuan ilmiah / seminar				
	4. Pengembangan program kuliah / Kelompok Ilmu Elektro				
	5. Menjadi anggota panitia / Badan pada suatu Perguruan Tinggi				
	6. Menjadi anggota Badan Lembaga Pemerintah				
	7. Menjadi Anggota Organisasi Profesi				
	8. Mewakili PT / Lembaga Pemerintah duduk dalam Panitia antar Lembaga				
	9. Menjadi Anggota Delegasi Nasional ke Parlemen - Parlemen Internasional				
Jumlah Total				16	

Kepada yang bersangkutan akan diberikan gaji / honorarium sesuai dengan peraturan penggajian yang berlaku di Institut Sains dan Teknologi Nasional  
Penugasan ini berlaku dari tanggal 20 Maret 2023 sampai dengan tanggal 31 Agustus 2023.









Jakarta, 20 Maret 2023  
Dekan,

(Dr. Musirah Cahya F.T.S.Si.,M.Si.)

Tembusan :

1. Direktur Akademik - ISTN
2. Direktur Non Akademik - ISTN
3. Ka. Biro Sumber Daya Manusia - ISTN
4. Kepala Program Studi Fak. ....
5. Arsip

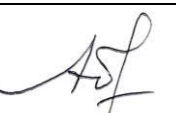
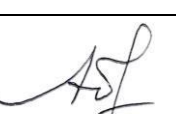
<b>BERITA ACARA PERKULIAHAN</b> <b>(PRESENTASI KEHADIRAN DOSEN)</b> <b>SEMESTER GENAP TAHUN AKADEMIK 2022/2023</b> <b>PROGRAM STUDI TEKNIK EILEKTRO S.1 &amp; D.III -ISTN</b>		
Mata Kuliah : <b>MESIN MESIN LISTRIK</b> Dosen : 1. Dr. Ir. H. Abdul Multi, M.T 2. Sugianto, Ir. MT. Hari : <b>Sabtu</b> Jam : 17:00-18:40	Semester : 6 SKS : 3 Kelas : K Ruang :	

No.	TANGGAL	MATERI KULIAH	JML MHS HADIR	TANDA TANGAN DOSEN
1.	01/4/2023	<ul style="list-style-type: none"> <li>- INTRODUCTION/PREFACE</li> <li>- Lecture material</li> <li>- References/books</li> </ul>	4	
2.	08/4/2023	Jenis-Jenis : - Mesin Listrik, <ul style="list-style-type: none"> <li>- Belitan</li> <li>- Mesin Sinkron, - Suplai daya dc ke rotor</li> </ul>	4	
3.	15/4/2023	<ul style="list-style-type: none"> <li>- Tegangan Yang Dibangkitkan Internal</li> <li>- Rangkaian Ekivalen Generator</li> </ul>	4	
4.	29/4/2023	Rangkaian Ekivalen Generator Sinkron	4	
5.	06/5/2023	Diagram Phasor & Aliran Daya	4	
6.	13/5/2022	Pengujian Generator Sinkron	4	
7.	20/5/2023	Ujian Tengah Semester	4	
8.	27/5/2023	Ujian Tengah Semester	4	







DOSEN PENGAJAR



(Ir. Sugianto, M.T)

**BERITA ACARA PERKULIAHAN**  
**(PRESENTASI KEHADIRAN DOSEN)**  
**SEMESTER GENAP TAHUN AKADEMIK 2022/2023**  
**PROGRAM STUDI TEKNIK ELEKTRO S.1 & D.III -ISTN**

Mata Kuliah	: Mesin-mesin Listrik(MML)	Semester	: Genap 2022/2023
Dosen	: Dr.Ir.H.A.Multi Msc/Sugianto, Ir.MT	SKS	: 3
Hari	: Sabtu	Kelas	: K/P2k
Jam	: 17:00-18:40	Ruang	: On line

No.	TANGGAL	MATERI KULIAH	JML MHS HADIR	TANDA TANGAN DOSEN
9.	3-6-2023	Konsep Dasar Motor Induksi Phase 3, Kontruksi dan Bagian-Bagiannya.	3	
10.	10-6-2023	Konsep Motor Slip, Daya Input/Output dan Torsi Beban	3	
11.	17-6-2023	Daya dan Torsi Induksi Motor Serta Rugi-Rugi Motor dan Diagram Daya	3	
12.	24-6-2023	Effisiensi Motor Induksi, Daya Output dan Input serta contoh contoh soalnya.	2	
13.	1-7-2023	Rangkaian Induksi motor , Rangkaian Impedansi dan menghitung Z impedansi.	3	
14.	8-7-2023	Menghitung impedansi total , Rangkaian Ekuivalen dan Torsi Induksi	3	
15.	15-7-2023	Menghitung daya daya motor dan contoh contoh soal	3	
16.		<b>UJIAN AKHIR SEMESTER (UAS)</b>		

DOSEN PENGAJAR



( Ir.Sugianto, MT )

## DAFTAR NILAI

### SEMESTER GENAP REGULER TAHUN 2022/2023

Program Studi : Teknik Elektro S1

Matakuliah : Mesin Mesin Listrik

Kelas / Peserta : K

Perkuliahan : Kampus ISTN Bumi Srengseng P2K - Kelas

Dosen : Dr. Ir. H. Abdul Multi, MT/Ir.Sugianto,MT

Hal. 1/1

No	NIM	N A M A	ABSEN	TUGAS	UTS	UAS	MODEL	PRESENTASI	NA	HURUF
			10%	20%	30%	40%	0%	0%		
1	20224001	<b>Andri Suparto</b>	100	60	85	80	0	0	79.5	<b>A-</b>
2	22224702	<b>Dodik Adhi Kris Nugroho</b>	100	60	90	78	0	0	80.2	<b>A</b>
3	22224703	<b>Jimmywal,Amd</b>	100	60	85	70	0	0	75.5	<b>A-</b>

Rekapitulasi Nilai							
A	1	B+	0	C+	0	D+	0
A-	2	B	0	C	0	D	0
		B-	0	C-	0	E	0

Jakarta, 4 August 2023

Dosen Pengajar



**Ir. Sugianto, MT**

# Motor Induksi

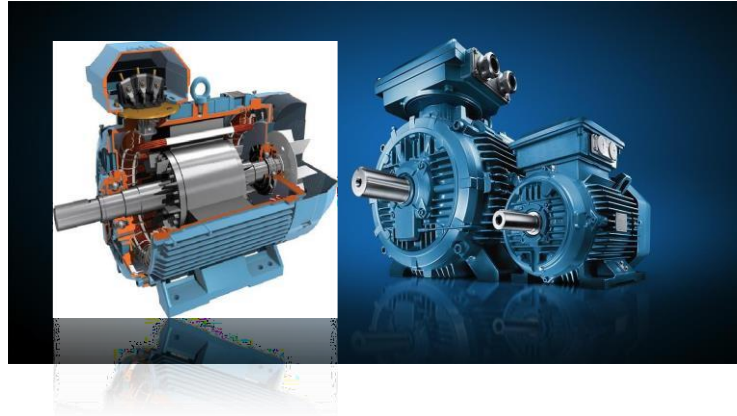

# KULIAH MOTOR INDUKSI

DI SUSUN OLEH :  
SUGIANTO,IR.MT & DR.A. MULTI .IR.MT



**AC** machines are generators that convert mechanical energy to ac electrical energy and motors that convert ac electrical energy to mechanical energy. The fundamental principles of ac machines are very simple, but unfortunately, they are somewhat obscured by the complicated construction of real machines. This chapter will first explain the principles of ac machine operation using simple examples, and then consider some of the complications that occur in real ac machines.

There are two major classes of ac machines—synchronous machines and induction machines. *Synchronous machines* are motors and generators whose magnetic field current is supplied by a separate dc power source, while *induction machines* are motors and generators whose field current is supplied by magnetic induction (transformer action) into their field windings. The field circuits of most synchronous and induction machines are located on their rotors. This chapter covers some of the fundamentals common to both types of three-phase ac machines. Synchronous machines will be covered in detail in Chapters 5 and 6, and induction machines will be covered in Chapter 7.



Ac machines differ from dc machines in that their *armature windings* are almost always located on the *stator*, while their *field windings* are located on the *rotor*. The rotating magnetic field from the rotor field windings of an ac machine induces a three-phase set of ac voltages into its stator armature windings. Conversely, a three-phase set of currents in the stator armature windings produces a rotating magnetic field which interacts with the rotor magnetic field, producing a torque in the machine. These two effects are the ac machine's version of generator action and motor action, and they must be thoroughly understood in any study of ac machines.



# INDUCTION MOTORS

In the last chapter, we saw how amortisseur windings on a synchronous motor could develop a starting torque without the necessity of supplying an external field current to them. In fact, amortisseur windings work so well that a motor could be built without the synchronous motor's main dc field circuit at all. A machine with only amortisseur windings is called an *induction machine*. Such machines are called induction machines because the rotor voltage (which produces the rotor current and the rotor magnetic field) is *induced* in the rotor windings rather than being physically connected by wires. The distinguishing feature of an induction motor is that *no dc field current is required* to run the machine.

Although it is possible to use an induction machine as either a motor or a generator, it has many disadvantages as a generator and so is rarely used in that manner. For this reason, induction machines are usually referred to as induction motors.

## 7.1 INDUCTION MOTOR CONSTRUCTION

An induction motor has the same physical stator as a synchronous machine, with a different rotor construction. A typical two-pole stator is shown in Figure 7–1. It looks (and is) the same as a synchronous machine stator. There are two different types of induction motor rotors which can be placed inside the stator. One is called a *cage rotor*, while the other is called a *wound rotor*.

Figures 7–2 and 7–3 show cage induction motor rotors. A cage induction motor rotor consists of a series of conducting bars laid into slots carved in the face of the rotor and shorted at either end by large *shorting rings*. This design is referred to as a cage rotor because the conductors, if examined by themselves, would look like one of the exercise wheels that squirrels or hamsters run on.

# Konstruksi Motor Induksi

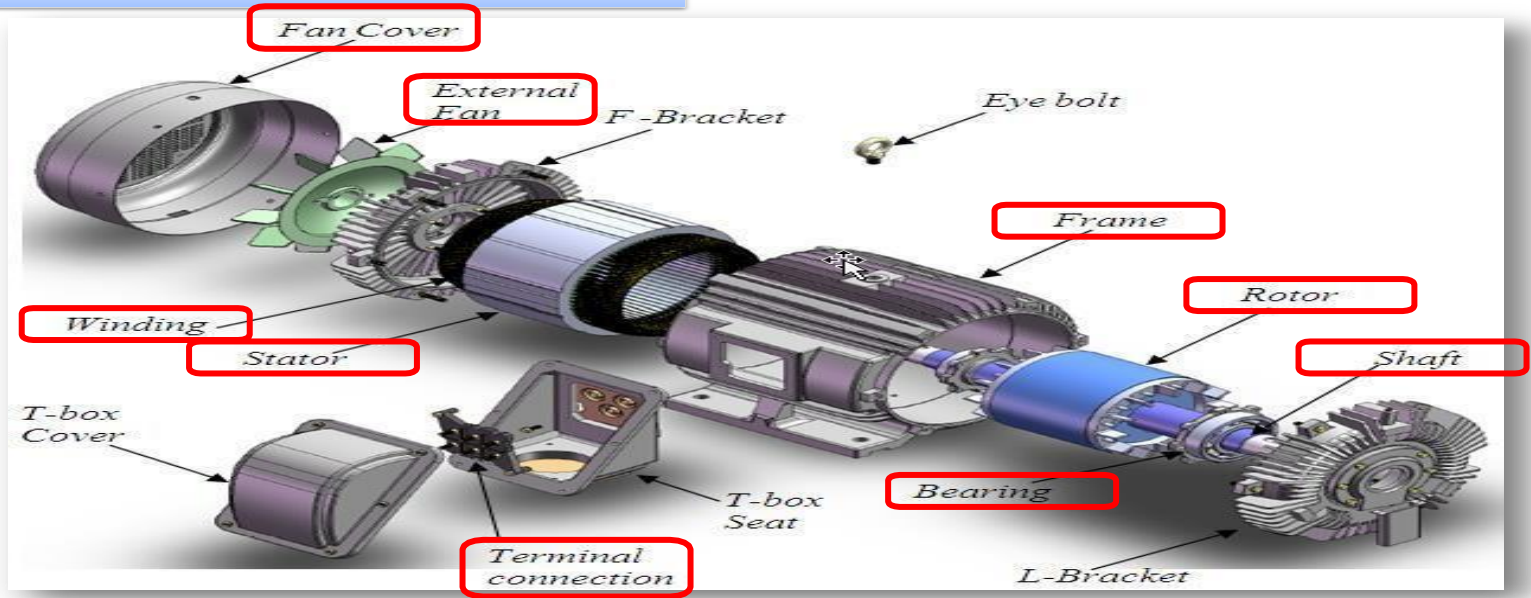

*cage rotor,*

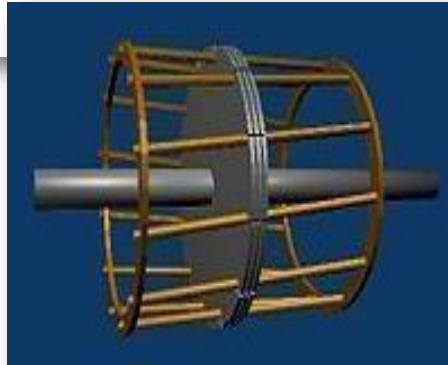
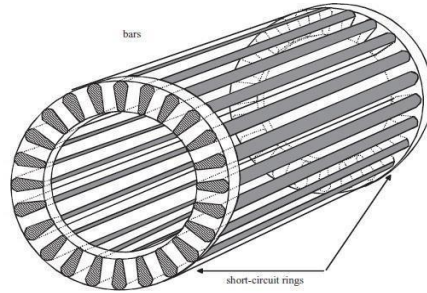

## squirrel-cage rotor

### Copper Squirrel Cage Construction

- Copper bar rotor construction is available upon request, or to meet API 541 4th Edition Specification.
- Greater capability of starting high inertia loads.

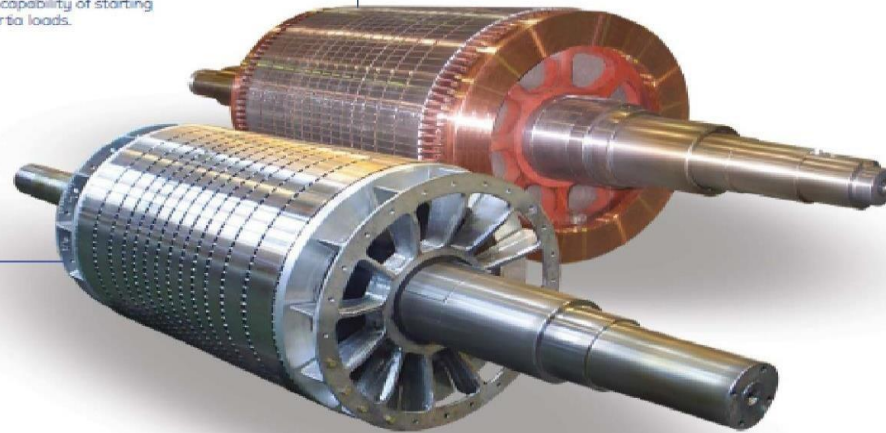

### Aluminum Squirrel Cage Construction

- Fabricated aluminum rotor windings are repairable. GE Motors Ai-Tight® construction is available now on fabricated aluminum rotors. This new process technique assures rotor integrity and reliable performance.
- Bar tension maintains punching tightness.
- A larger number of rotor bar shapes for optimum torque vs. slip designs.
- Cage migration eliminated with end-rings tight against the punchings.
- Lower rotor inertia. Lower weight bars and end-rings reduce the centrifugal force, retaining rings are not required on the end-ring for standard designs.
- Closed rotor slots, reduced windage noise.



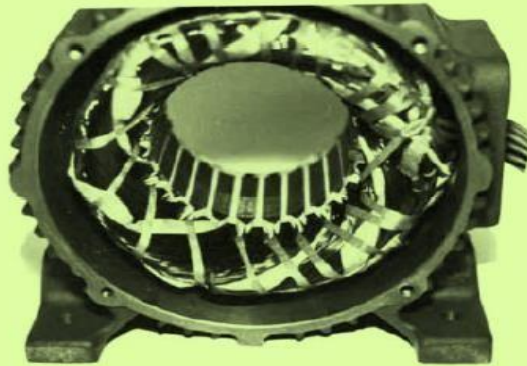

the stator

**FIGURE 7-1**  
The stator of a typical induction motor, showing the stator windings. (Courtesy of MagneTek, Inc.)

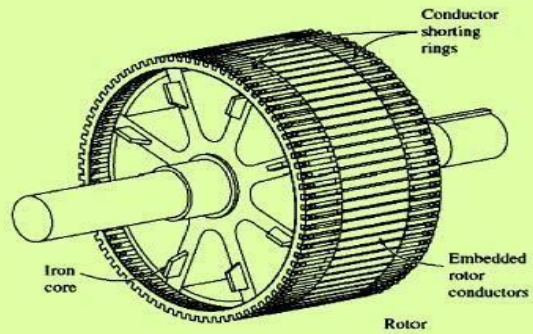

cage rotor,

(a)

*cage rotor,*

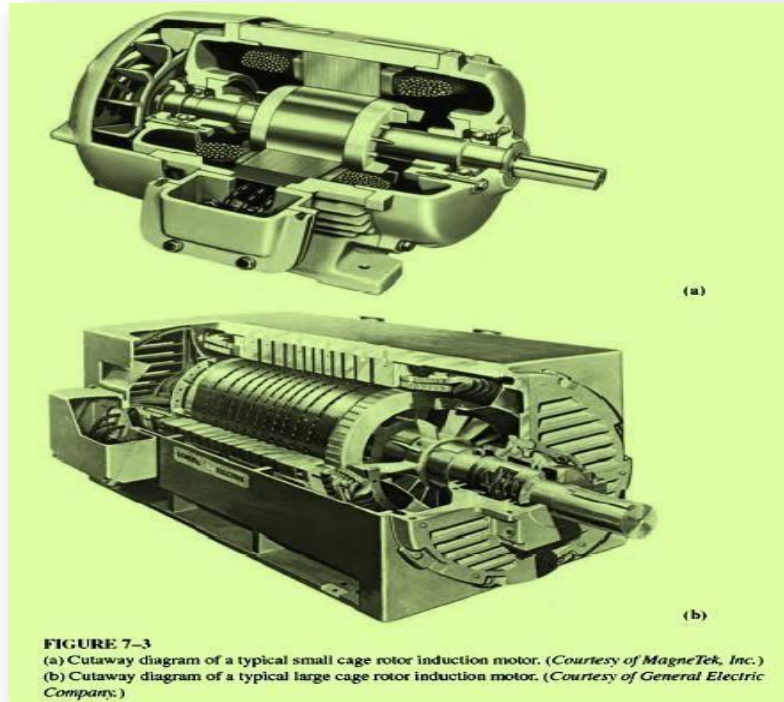



The other type of rotor is a wound rotor. A *wound rotor* has a complete set of three-phase windings that are mirror images of the windings on the stator. The three phases of the rotor windings are usually Y-connected, and the ends of the three rotor wires are tied to slip rings on the rotor's shaft. The rotor windings are shorted through brushes riding on the slip rings. Wound-rotor induction motors therefore have their rotor currents accessible at the stator brushes, where they can be examined and where extra resistance can be inserted into the rotor circuit. It is possible to take advantage of this feature to modify the torque–speed characteristic of the motor. Two wound rotors are shown in Figure 7–4, and a complete wound-rotor induction motor is shown in Figure 7–5.

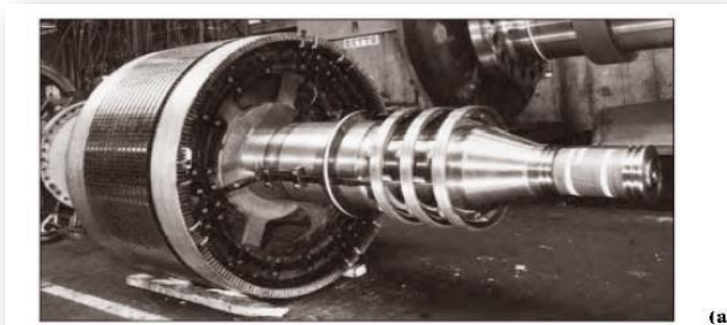

(a)

*wound rotor.*



(b)

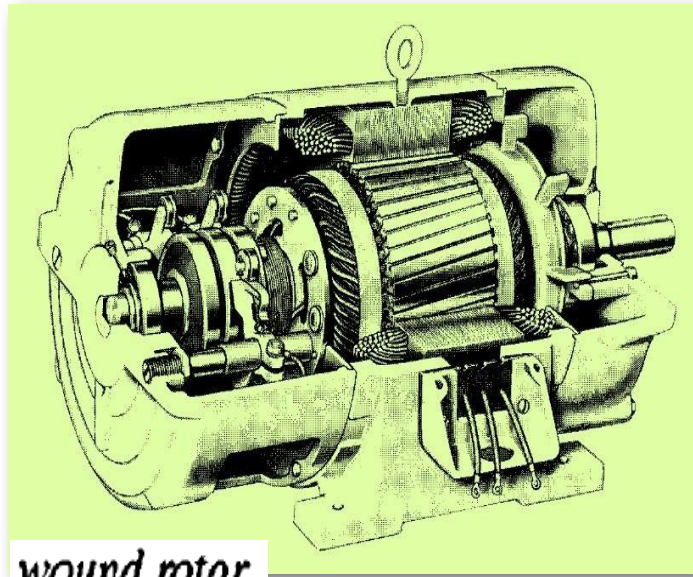

*wound rotor.*

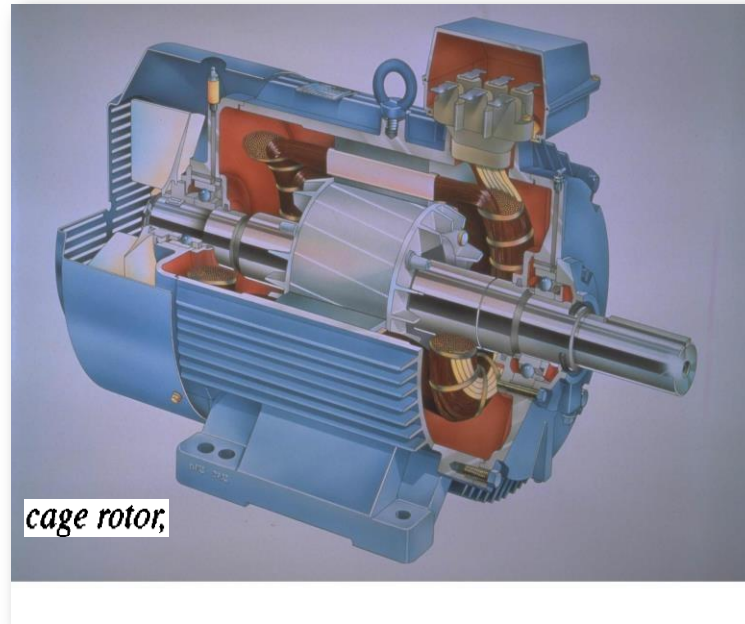

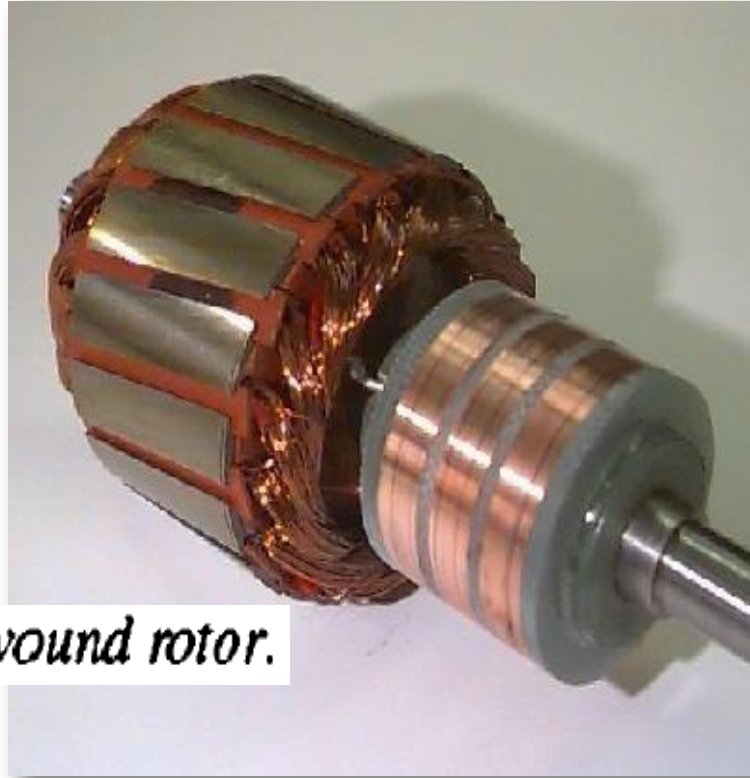

*wound rotor.*



*wound rotor.*

## TYPICAL WOUND-ROTOR INDUCTION MOTOR

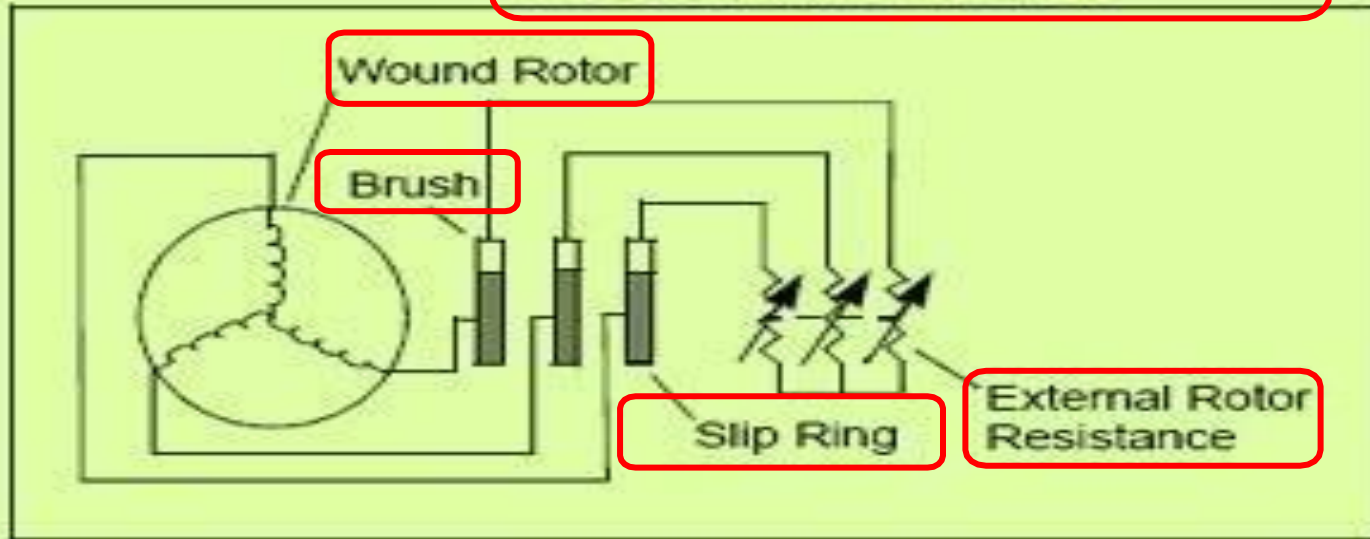



Wound-rotor induction motors are more expensive than cage induction motors, and they require much more maintenance because of the wear associated with their brushes and slip rings. As a result, wound-rotor induction motors are rarely used.

## 7.2 BASIC INDUCTION MOTOR CONCEPTS

Induction motor operation is basically the same as that of amortisseur windings on synchronous motors. That basic operation will now be reviewed, and some important induction motor terms will be defined.

### The Development of Induced Torque in an Induction Motor

Figure 7–6 shows a cage rotor induction motor. A three-phase set of voltages has been applied to the stator, and a three-phase set of stator currents is flowing. These currents produce a magnetic field  $\mathbf{B}_s$ , which is rotating in a counterclockwise direction. The speed of the magnetic field's rotation is given by

$$n_{sync} = \frac{120 f_e}{P}$$

(7-1)

where  $f_e$  is the system frequency in hertz and  $P$  is the number of poles in the machine. This rotating magnetic field  $\mathbf{B}_s$  passes over the rotor bars and induces a voltage in them.

The voltage induced in a given rotor bar is given by the equation

$$e_{\text{ind}} = (\mathbf{v} \times \mathbf{B}) \cdot \mathbf{l} \quad (1-45)$$

where  $\mathbf{v}$  = velocity of the bar *relative to the magnetic field*

$\mathbf{B}$  = magnetic flux density vector

$\mathbf{l}$  = length of conductor in the magnetic field

It is the *relative* motion of the rotor compared to the stator magnetic field that produces induced voltage in a rotor bar. The velocity of the upper rotor bars relative to the magnetic field is to the right, so the induced voltage in the upper bars is out of the page, while the induced voltage in the lower bars is into the page. This results in a current flow out of the upper bars and into the lower bars. However, since the rotor assembly is inductive, the peak rotor current lags behind the peak rotor voltage (see Figure 7-6b). The rotor current flow produces a rotor magnetic field  $\mathbf{B}_R$ .

Finally, since the induced torque in the machine is given by

$$\tau_{\text{ind}} = k\mathbf{B}_R \times \mathbf{B}_s \quad (4-58)$$

the resulting torque is counterclockwise. Since the rotor induced torque is counterclockwise, the rotor accelerates in that direction.



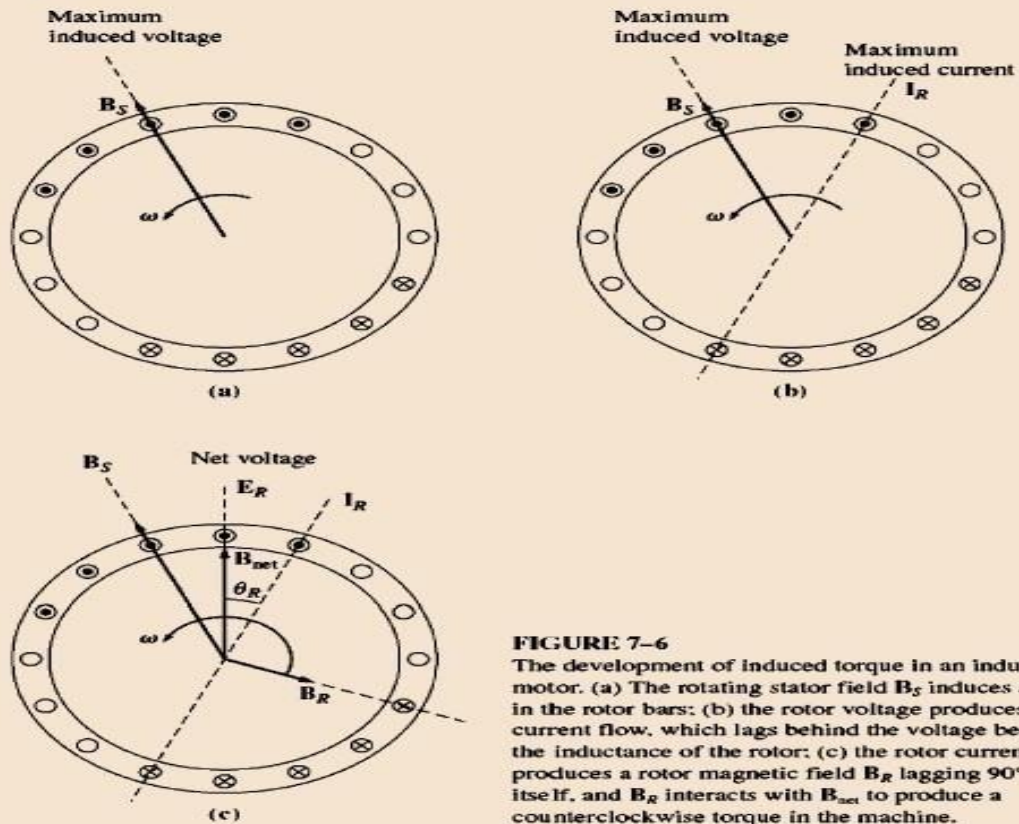

**FIGURE 7-6**

The development of induced torque in an induction motor. (a) The rotating stator field  $B_S$  induces a voltage in the rotor bars; (b) the rotor voltage produces a rotor current flow, which lags behind the voltage because of the inductance of the rotor; (c) the rotor current produces a rotor magnetic field  $B_R$  lagging  $90^\circ$  behind itself, and  $B_R$  interacts with  $B_{net}$  to produce a counterclockwise torque in the machine.

There is a finite upper limit to the motor's speed, however. If the induction motor's rotor were turning at *synchronous speed*, then the rotor bars would be stationary *relative to the magnetic field* and there would be no induced voltage. If  $e_{\text{ind}}$  were equal to 0, then there would be no rotor current and no rotor magnetic field. With no rotor magnetic field, the induced torque would be zero, and the rotor would slow down as a result of friction losses. An induction motor can thus speed up to near-synchronous speed, but it can never exactly reach synchronous speed.

Note that in normal operation *both the rotor and stator magnetic fields  $\mathbf{B}_R$  and  $\mathbf{B}_S$  rotate together at synchronous speed  $n_{\text{sync}}$ , while the rotor itself turns at a slower speed.*