

BIDANG PENDIDIKAN DAN PENGAJARAN
BERITA ACARA PERKULIAHAN
KULIAH OFF-LINE

PERIODE SEMESTER GENAP 2022-2023

MATA KULIAH:

DASAR ELEKTRONIKA KLAS A

LAMPIRAN BERITA ACARA PERKULIAHAN :

- 1. SK.DEKAN FTI SEMESTER GENAP 2022/2023*
- 2. PRESENSI KEHADIRAN MAHASISWA & DOSEN*
- 3. CONTOH HAND OUT MATERI AJAR*
- 4. NILAI KOMULATIF; KEHADIRAN, TUGAS, UTS DAN UAS*

PROGRAM STUDI TEKNIK ELEKTRO
FAKULTAS TEKNOLOGI INDUSTRI
INSTITUT SAINS DAN TEKNOLOGI NASIONAL



YAYASAN PERGURUAN CIKINI
INSTITUT SAINS DAN TEKNOLOGI NASIONAL

Jl. Moh. Kahfi II, Bhumi Srengseng Indah, Jagakarsa, Jakarta Selatan 12640
Telp. 021-7270090 (hunting), Fax. 021-7866955, hp: 081291030024
Email : humas@istn.ac.id Website : www.istn.ac.id

SURAT PENUGASAN TENAGA PENDIDIK

Nomor : **99** / 03.1 – G / III / 2023

SEMESTER **GENAP**, TAHUN AKADEMIK 2022 / 2023

Nama	: Edy Supriyadi,Ir,MT	Status Pegawai	: Edukatif Tetap / Tidak Tetap			
NIK	: 22870030	Program Studi	: Teknik Elektro			
Jabatan Akademik	: Lektor Kepala					
Bidang	Perincian Kegiatan	Tempat	Jam/ Minggu	Kinerja (sks)	Keterangan	
I PENDIDIKAN Dan PENGAJARAN	MENGAJAR DI KELAS (KULIAH / RESPONSI DAN LABORATORIUM)					
	1.Dasar Sistem Kendali (Kls A)			2	Senin,08.00-09.40	
	2.Sistem Kendali Digital (Kls A)			3	Senin,10.00-12.30	
	3.Elektronika Terpadu (D.III Kls A)			2	Senin, 15.00- 16.40	
	4.Dasar Elektronika (Kls K)			2	Selasa, 13.00-14.40	
	5.Sistem Kendali Waktu Nyata (Kls A)			3	Kamis,13.00-14.40	
	6.					
	7.					
	8.					
	9.					
	10.					
	11.					
	12.					
	13.					
	14.					
	15.					
	16.					
	17. Membimbing Skripsi / Tugas Akhir					
18. Menguji Skripsi / Tugas Akhir				1		
II PENELITIAN	1. Penelitian Ilmiah			1		
	2. Penulisan Karya Ilmiah			1		
	3. Penulisan Diktat Kuliah					
	4. Menerjemahkan Buku					
	5. Pembuatan Rancangan Teknologi					
	6. Pembuatan Rancangan & Karya Pertunjukan					
III PENGABDIAN DAN MASYARAKAT	1. Menduduki Jabatan di Pemerintahan					
	2. Pengembangan Hasil Pendidikan Dan Penelitian					
	3. Memberikan Penyuluhan/Pelatihan/Ceramah pada masyarakat				1	
	4. Memberikan Pelayanan Kepada Masyarakat Umum					
	5. Menulis Karya Pengabdian Pada Masyarakat yang tidak dipublikasikan					
	6. Komersial / Kesepakatan					
IV UNSUR-UNSUR PENUNJANG	1. Jabatan Struktural					
	2. Penasehat Akademik					
	3. Berperan serta aktif dalam pertemuan ilmiah / seminar				1	
	4. Pengembangan program kuliah / Kelompok Ilmu Elektro					
	5. Menjadi anggota panitia / Badan pada suatu Perguruan Tinggi					
	6. Menjadi anggota Badan Lembaga Pemerintah					
	7. Menjadi Anggota Organisasi Profesi					
	8. Mewakili PT / Lembaga Pemerintah duduk dalam Panitia antar Lembaga					
	9. Menjadi Anggota Delegasi Nasional ke Parlemen – Parlemen Internasional					
Jumlah Total				17		
Kepada yang bersangkutan akan diberikan gaji / honorarium sesuai dengan peraturan penggajian yang berlaku di Institut Sains dan Teknologi Nasional Penugasan ini berlaku dari tanggal 20 Maret 2023 sampai dengan tanggal 31 Agustus 2023 .						
 Jakarta, 20 Maret 2023 Dekan, (Dr. Musfirah Cahya F.T.S.Si., M.Si.)						

Tembusan :

1. Direktur Akademik - ISTN
2. Direktur Non Akademik – ISTN
3. Ka. Biro Sumber Daya Manusia - ISTN
4. Kepala Program Studi Fak.
5. Arsip



Berita Acara Perkuliahan
(Presentasi Kehadiran Dosen)
SEMESTER GENAP TAHUN AKADEMIK 2022/2023
PROGRAM STUDI TEKNIK ELEKTRO S1 FTI - ISTN

Nama Dosen		: 1. Ir. Edy Supriyadi, MT			Hari		: Selasa
Mata Kuliah		: Dasar Elektronika			Jam		: 13.00-14.40
Kelas		: A			Ruang		: C-3
No.	Hari / Tanggal	Materi Pembelajaran	Metode Belajar	Jml Mhs	Paraf Dosen		
1.	Selasa / 21-03-2023	Pendahuluan; Koordinasi perkuliahan, orientasi mata kuliah dan aturan DI KELAS	Tatap Muka ke-1	1			
2.	Selasa / 28-03-2023	Komponen Pasif , Hukum dan Teori Rangkaian (Tugas 1 : Komponen Pasif R, L, C)	Tatap Muka ke-2	1			
3.	Selasa / 04-04-2023	Teori Atom dan Semikonduktor (Tugas 2 Teori Dioda dan rangkaian diode)	Tatap Muka ke-3	1			
4.	Selasa / 11-04-2023	Dioda persambungan pn	Tatap Muka ke-4	1			
5.	Selasa / 18-04-2023	Rangkaian Dioda (Quis : analisa rangkaian diode)	Tatap Muka ke-5	1			
6.	Selasa / 02-05-2023	Rangkaian Dioda dan Latihan soal serta Quis	Tatap Muka ke-6	1			
7.	Selasa / 09-05-2023	Macam-macam Dioda dan latihan soal soal	Tatap Muka ke-7	1			
8.	Selasa / 16-05-2023	UJIAN TENGAH SEMESTER (UTS) SEMESTER GENAP 2022/2023	Ujian UTS	1			



Berita Acara Perkuliahan
(Presentasi Kehadiran Dosen)
SEMESTER GENAP TAHUN AKADEMIK 2022/2023
PROGRAM STUDI TEKNIK ELEKTRO S1 FTI - ISTN

Nama Dosen	: 1. Ir. Edy Supriyadi, MT	Hari	: Selasa		
Mata Kuliah	: Dasar Elektronika	Jam	: 13.00-14.40		
Kelas	: A	Ruang	:		
No.	Hari / Tanggal	Materi Pembelajaran	Metode Belajar	Jml Mhs	Paraf Dosen
9	Selasa / 06-06-2023	Pembahasan Catudaya dan Analisanya serta Tugas 5	Tatap Muka ke-9	1	
10	Selasa / 13-06-2023	Rangkaian Clipper dan Clamper	Tatap Muka ke-10	1	
11	Selasa / 20-06-2023	Rangkaian Pengganda Tegangan	Tatap Muka ke-11	1	
12	Selasa / 27-06-2023	Analisa Rangkaian Dioda Zener sebagai Penstabil Tegangan dan Tugas 6	Tatap Muka ke-12	1	
13	Selasa / 04-07-2023	Prinsip Dasar Transistor	Tatap Muka ke-13	1	
14	Selasa / 11-07-2023	Macam macam jenis Transistor	Tatap Muka ke-14	1	
15	Selasa / 18-07-2023	Riview dan diskusi mengenai tugas tugasnya	Tatap Muka ke-15	1	
16	Selasa / 25-07-2023	UJIAN AKHIR SEMESTER GENAP 2223	Ujian UAS	1	

Jakarta, 2023

Mengetahui
Kepala Program Studi

Harlan Effendi, MT



**DAFTAR HADIR PESERTA KULIAH MAHASISWA
GENAP - REGULER - TAHUN 2022/2023**

FAK / JURUSAN
MATAKULIAH
KELAS / PESERTA
KURIKULUM
DOSEN

Teknik Elektro S1
Dasar Elektronika / 222002 / 2
A / 1
2018
1.Eddy Supriyadi, Ir.MT.

HARI / TANGGAL Selasa
JAM KULIAH 13:00-14:40
RUANG C-2

Hal : 1 / 1

No	NIM	NAMA MAHASISWA	TANGGAL PERTEMUAN								JUMLAH	
			21/3	28/3	4/4	11/4	18/4	2/5	9/5	16/5		
1	19220001	MUHAMMAD ISRA MAULANA	<i>[Signature]</i>	<i>[Signature]</i>	<i>[Signature]</i>	<i>[Signature]</i>	<i>[Signature]</i>	<i>[Signature]</i>	<i>[Signature]</i>	<i>[Signature]</i>	✓	

CATATAN :

Perubahan peserta hanya diperkenankan bila ada persetujuan tertulis dari Pelaksana Jurusan.

16/08/2023

Jakarta,

Dosen Pengajar,

(Eddy Supriyadi, Ir.MT.)



**DAFTAR HADIR PESERTA KULIAH MAHASISWA
GENAP - REGULER - TAHUN 2022/2023**

FAK / JURUSAN
MATAKULIAH
KELAS / PESERTA
KURIKULUM
DOSEN

Teknik Elektro S1
Dasar Elektronika / 222002 / 2
A / 1
2018
1.Eddy Supriyadi, Ir.MT.

HARI / TANGGAL Selasa
JAM KULIAH 13:00-14:40
RUANG C-2

Hal : 1 / 1

No	N I M	NAMA MAHASISWA	TANGGAL PERTEMUAN								JUMLAH
			6/6/23	13/6	20/6	27/6	4/7	11/7	18/7	25/7/23	
1	19220001	MUHAMMAD ISRA MAULANA									7

CATATAN :

Perubahan peserta hanya diperkenankan bila ada persetujuan tertulis dari Pelaksana Jurusan.

16/08/2023

Jakarta,

Dosen Pengajar,

(Eddy Supriyadi, Ir.MT.)

DAFTAR NILAI

SEMESTER GENAP REGULER TAHUN 2022/2023

Program Studi : Teknik Elektro S1

Matakuliah : Dasar Elektronika

Kelas / Peserta : A

Perkuliahan : Kampus ISTN Bumi Srengseng Indah

Dosen : Eddy Supriyadi, Ir.MT.

Hal. 1/1

No	NIM	N A M A	ABSEN	TUGAS	UTS	UAS	MODEL	PRESENTASI	NA	HURUF
			10%	20%	30%	40%	0%	0%		
1	19220001	Muhammad Isra Maulana	100	70	60	60	0	0	66	B-

Rekapitulasi Nilai							
A	0	B+	0	C+	0	D+	0
A-	0	B	0	C	0	D	0
		B-	1	C-	0	E	0

Jakarta, 1 August

2023 Dosen Pengajar



Eddy Supriyadi, Ir.MT.

Bahan Kuliah
DASAR ELEKTRONIKA

TRANSISTOR
Analisis DC dan titik kerja

TRANSISTOR

1. Transistor :komponen aktif dengan 3 kaki.
 - ❖ Satu kaki terhubung ke sumber daya,
 - ❖ satu kaki lain terhubung ke output dan
 - ❖ Satu kaki untuk mengatur daya output.
2. Transistors biasanya digunakan sbg :
 - Penguat
 - saklar.

JENIS TRANSISTOR

1. Transistor bipolar : BJT

- (Bipolar Junction Transistor)
- Aliran listrik : 2 pembawa muatan (hole **dan** elektron)

2. Transistor Unipolar: FET

- (Field-Effect Transistor)
- Aliran listrik : satu pembawa muatan (hole **atau** elektron bebas saja)

TRANSISTOR BIPOLAR

BJT : NPN dan PNP

1. Transistor NPN :

- collector diberi tegangan lebih positif dari emitter.

2. Transistor PNP :

- emitter diberi tegangan lebih positif dari collector.

BIPOLAR TRANSISTOR NPN

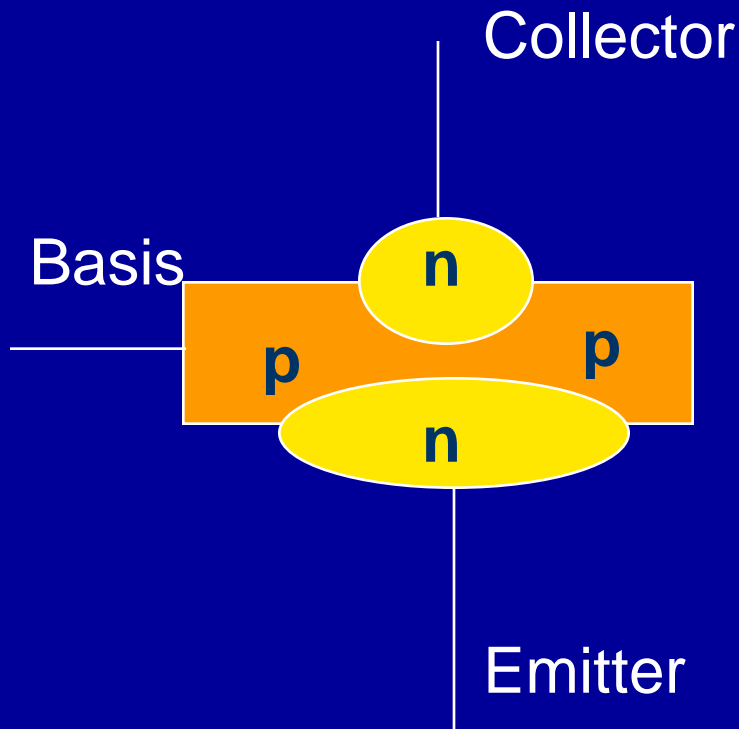

STRUKTUR

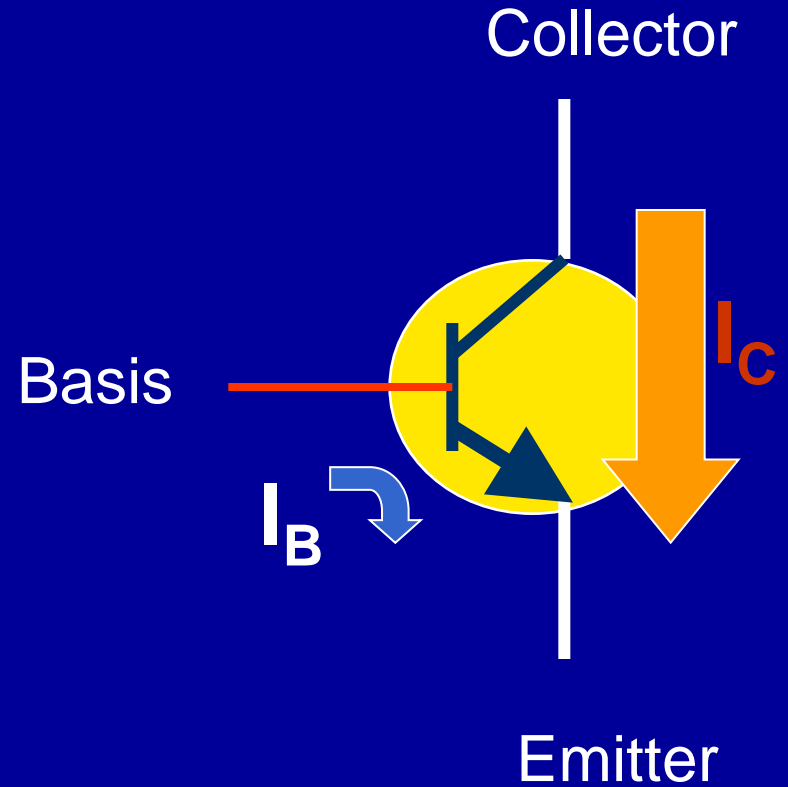

SIMBOL

OPERASI TRANSISTOR NPN

1. Sambungan **basis ke emitor** bersifat seperti dioda.
 - Arus basis terjadi bila **tegangan basis lebih positif terhadap emiter**
 - Arus basis meningkat dengan cepat bila **V_{BE} sekitar 0,6 V.**
2. Pada tegangan ini transistor disebut menghantar "**ON**" dan arus mengalir dari **kolektor ke emitor.**

BIPOLAR TRANSISTOR PNP

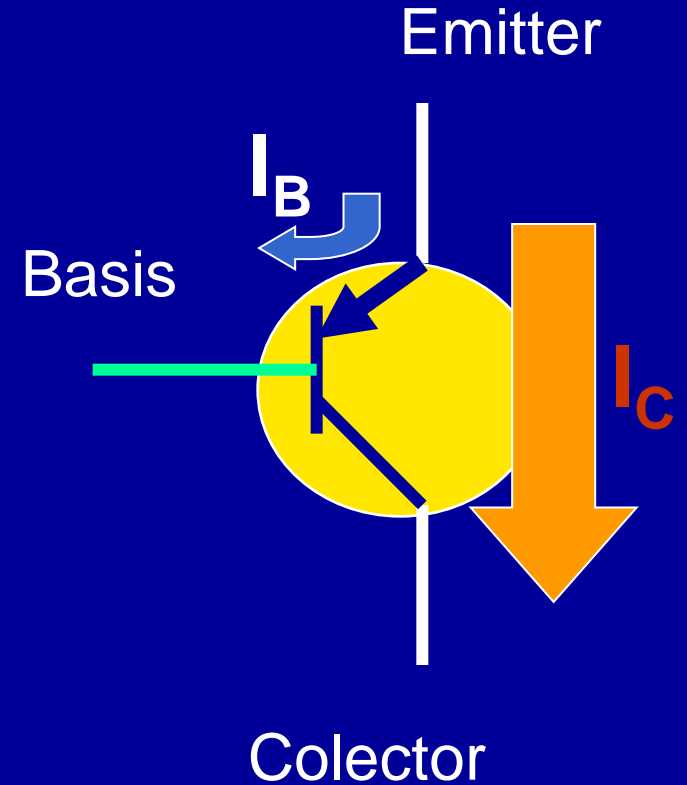
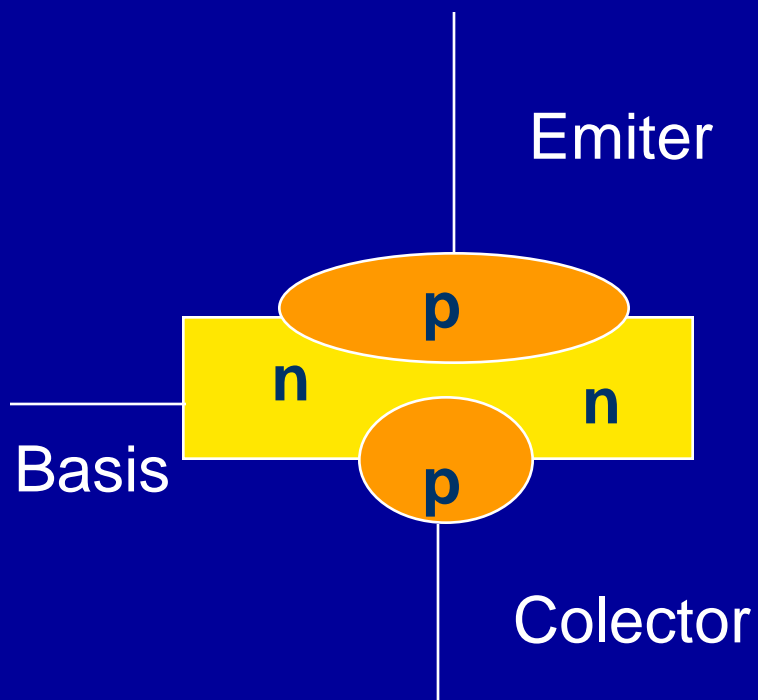

OPERASI TRANSISTOR PNP

1. Sambungan **emitor ke basis** bersifat seperti **dioda**.
 - Arus **emiter-basis** terjadi bila tegangan **basis lebih rendah terhadap emiter**
 - Arus ini meningkat dengan cepat bila V_{EB} **sekitar 0,6 V**.
2. Pada tegangan **emiter-basis** ini transistor disebut menghantar "**ON**" dan arus mengalir dari **emiter ke kolektor**.

ARUS KOLEKTOR

- Arus kolektor dikendalikan oleh V_{BE} sesuai dengan persamaan Ebers-Moll:

$$I_C = I_S \left(e^{\frac{V_{BE}}{V_T}} - 1 \right)$$

- I_S adalah arus maksimum transistor (disebut arus jenuh)
- $V_T = kT/e$.
- k adalah konstanta Boltzmann,
- T : suhu mutlak,
- e : muatan sebuah electron.
- V_T : sekitar 25 mV pada suhu kamar.

ARUS KOLEKTOR

- Arus kolektor dikendalikan oleh I_B sesuai dengan persamaan :

$$I_C = \beta I_B$$

- β adalah penguatan arus atau sering juga disebut disebut **HFE**

BANTUK FISIK

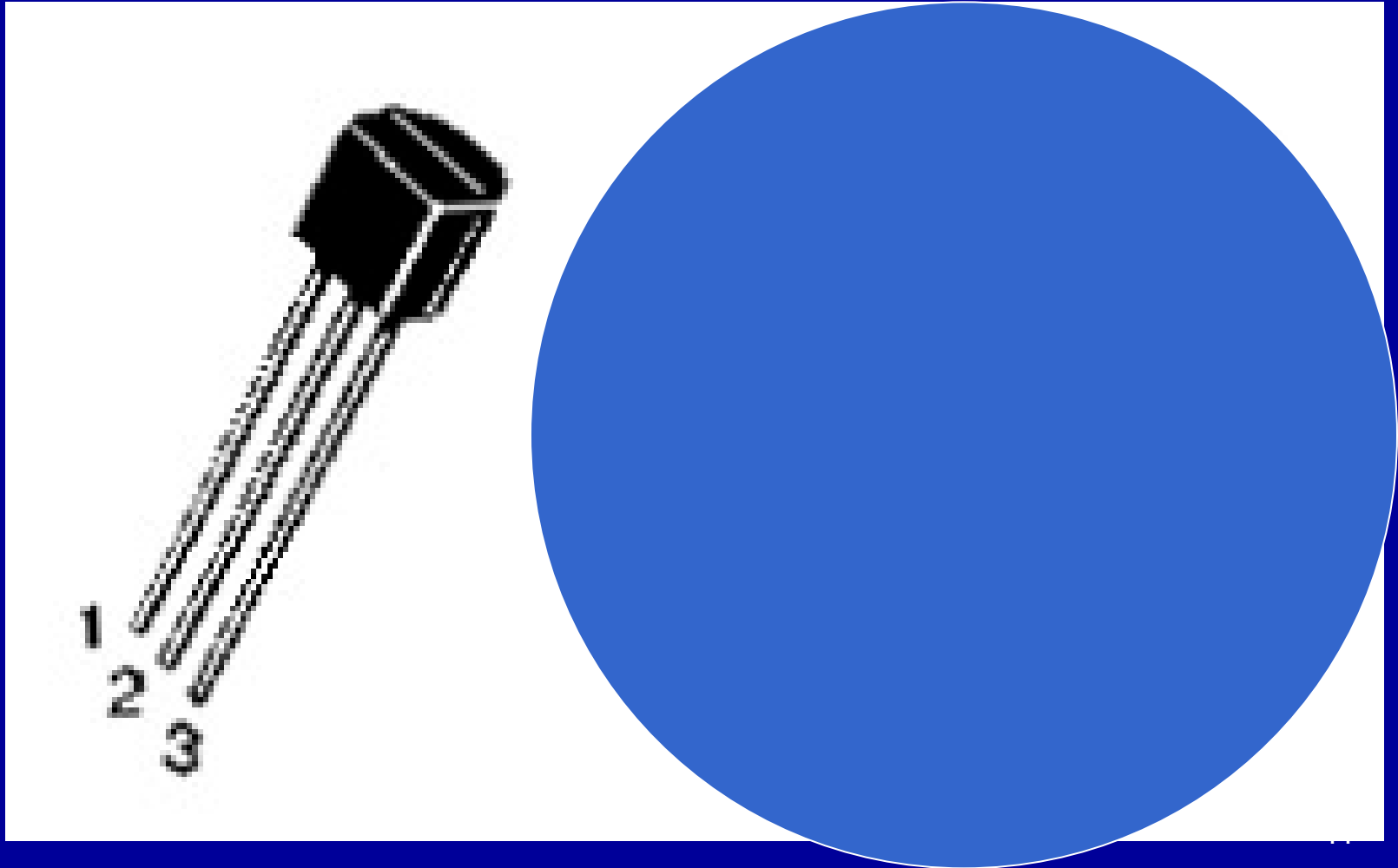

α (parameter Alfa)

Bagian arus kolektor thd arus emiter

$$\alpha = \frac{I_C}{I_E}$$

Biasanya,

$$\alpha = 0,95 \text{ to } 0,995$$

$$\beta = 20 \text{ to } 200.$$

KARAKTERISTIK TRANSISTOR

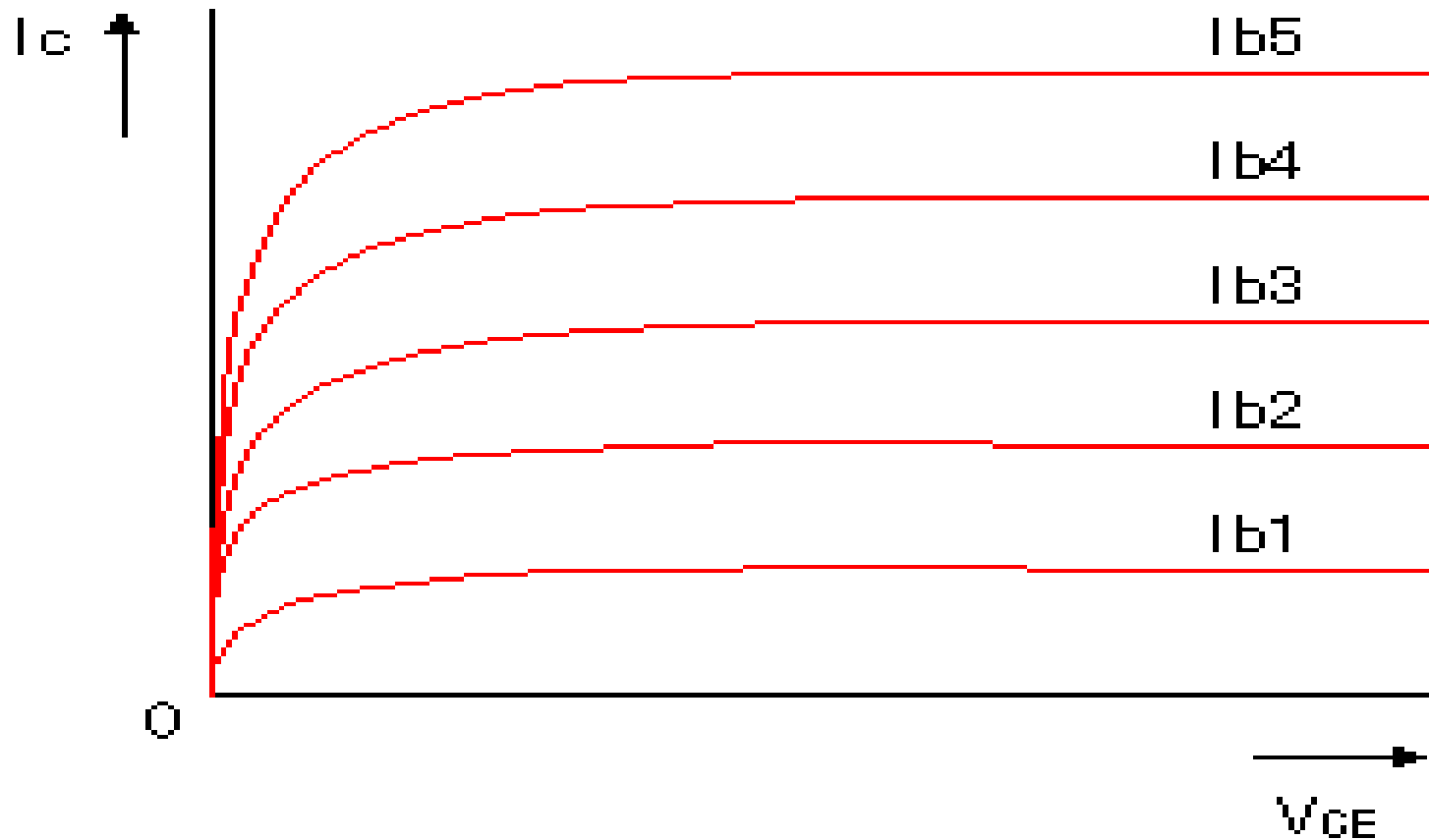

$$I_{b1} < I_{b2} < I_{b3} < I_{b4} < I_{b5}$$

Rangkaian Dasar Bias

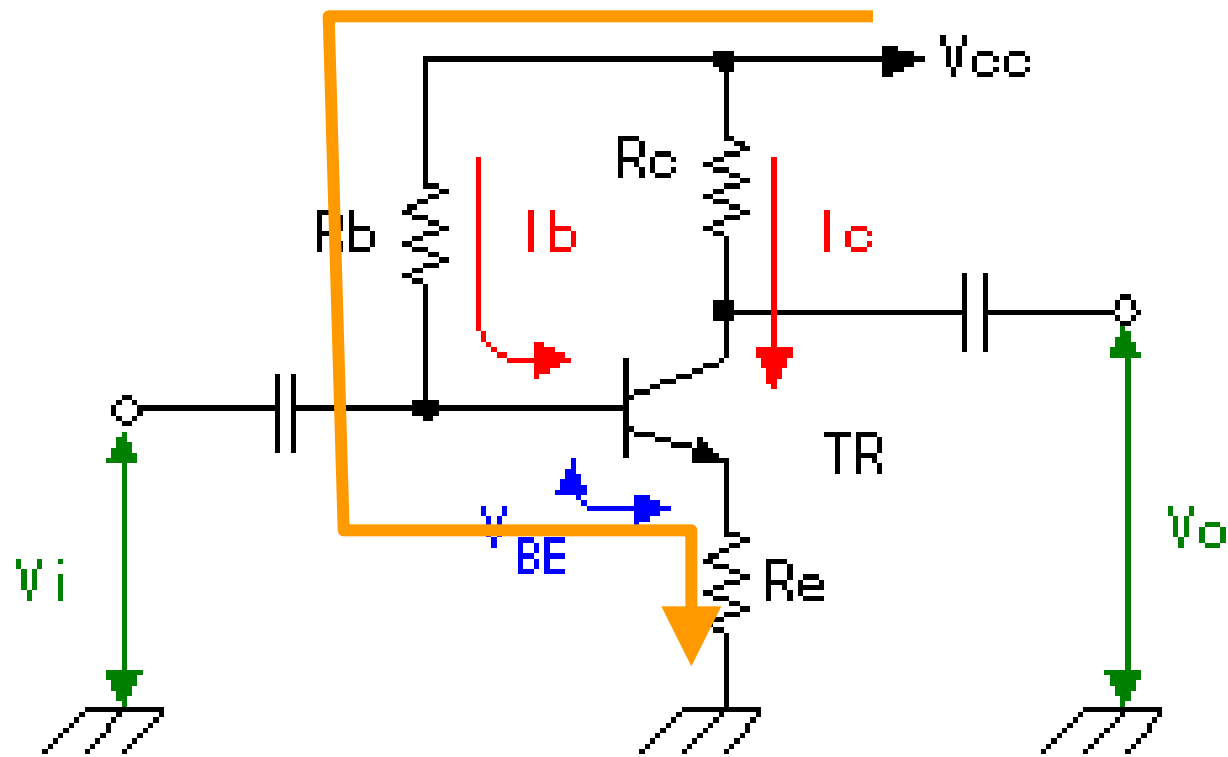

ARUS BASIS

Hukum Kirchoff : edaran VCC-basis-emiter-ground

$$V_{CC} = V_{Rb} + V_{BE} + V_{Re}$$

$$V_{CC} = I_B R_b + V_{BE} + (I_B + I_C) R_e$$

$$V_{CC} = I_B R_b + V_{BE} + (I_B + \beta I_B) R_e$$

$$I_b = \frac{V_{CC} - V_{BE}}{R_b + (\beta + 1) R_e}$$

TEGANGAN V_{CE}

$$V_{CC} = V_{R_c} + V_{CE} + V_{R_e}$$

$$V_{CC} = I_C R_c + V_{CE} + I_E R_e$$

$$V_{CC} = \beta I_B R_c + V_{CE} + (1 + \beta) I_B \times R_e$$

$$V_{CE} = V_{CC} - \beta I_B R_c - (1 + \beta) I_B \times R_e$$

$$V_{CE} = V_{CC} - \beta I_B (R_c + R_e)$$

ARUS BASIS LEWAT PEMBAGI TEGANGAN

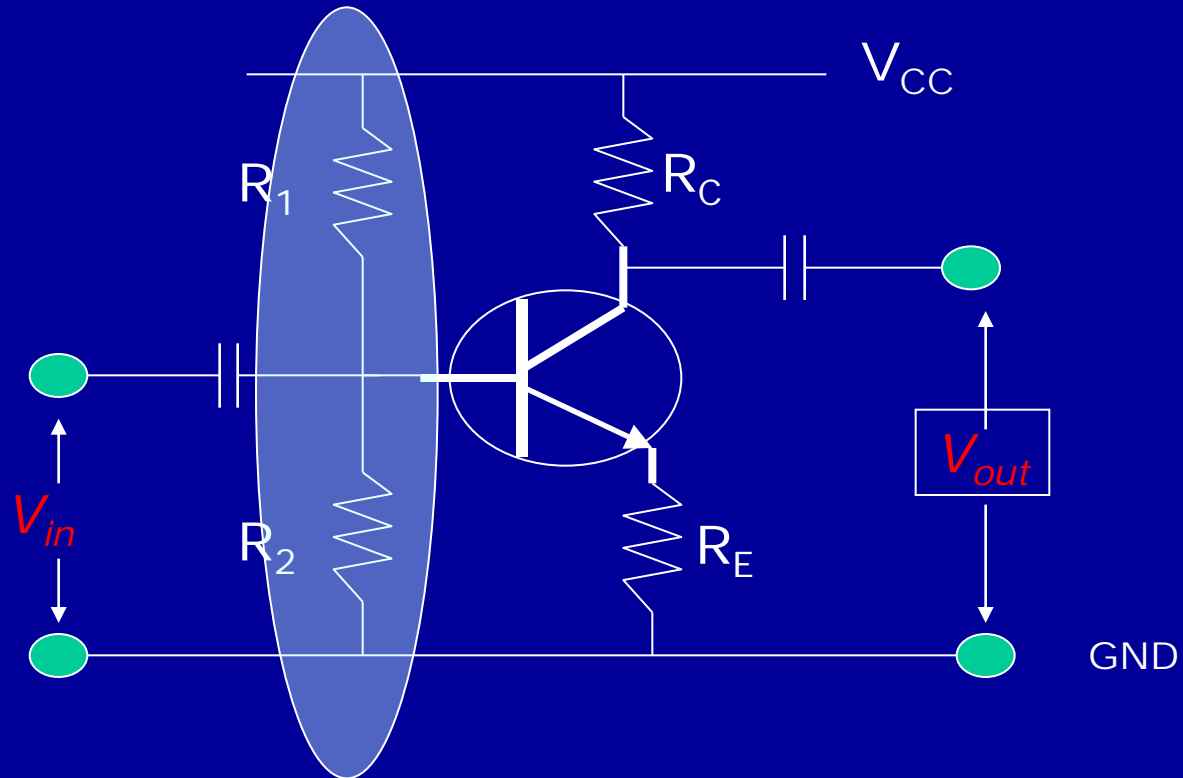

RANGKAIAN EKIVALEN THEVENIN

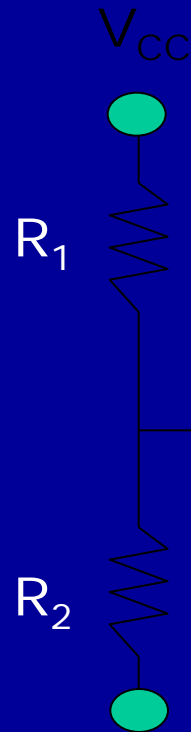

RANGKAIAN EKIVALEN THEVENIN

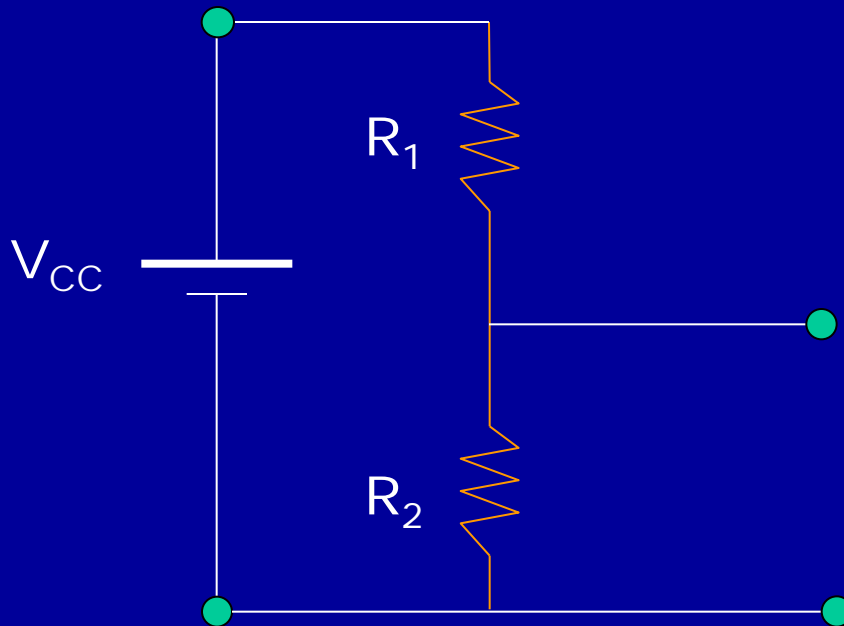

RANGKAIAN EKIVALEN THEVENIN

$$R_{th} = R_1 // R_2 = \frac{R_1 R_2}{R_1 + R_2}$$

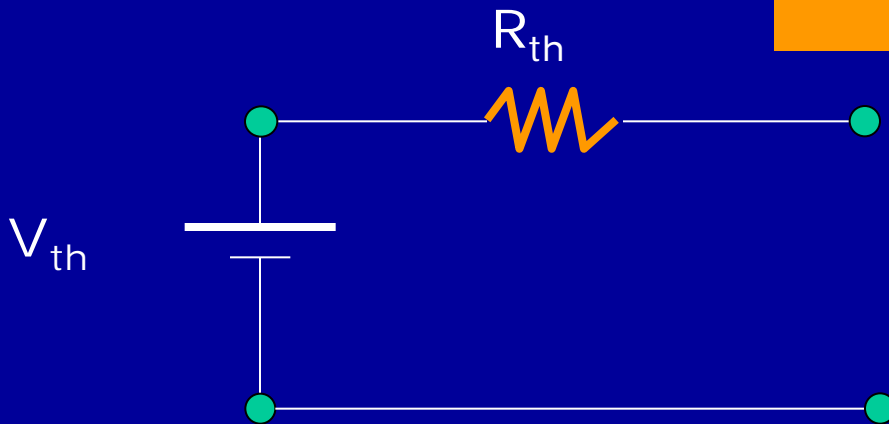

$$V_{th} = \frac{R_2}{R_1 + R_2} \times V_{CC}$$

MENGHITUNG ARUS BASIS I_B

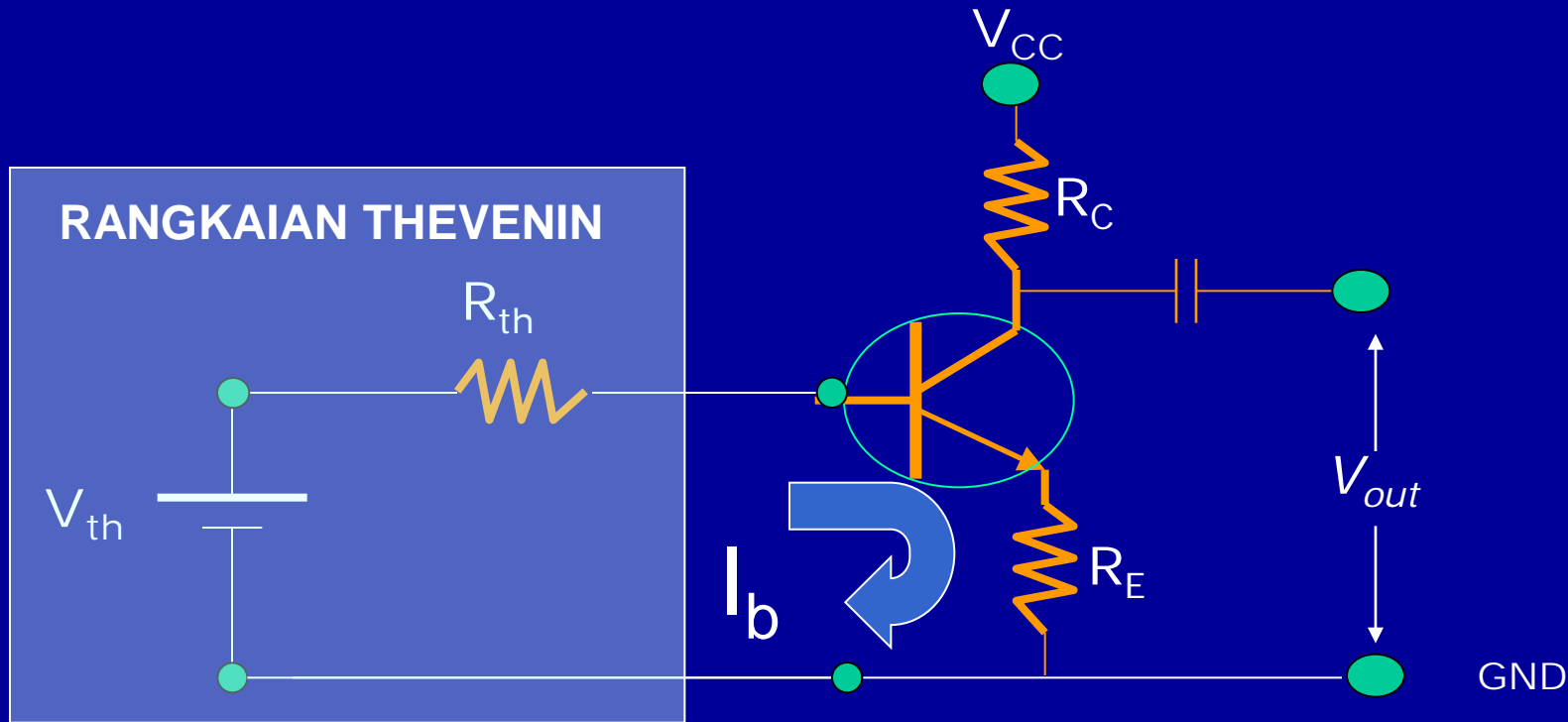

$$I_b = \frac{V_{th} - V_{BE}}{R_{th} + (\beta + 1)R_E}$$

ANALYSIS DC

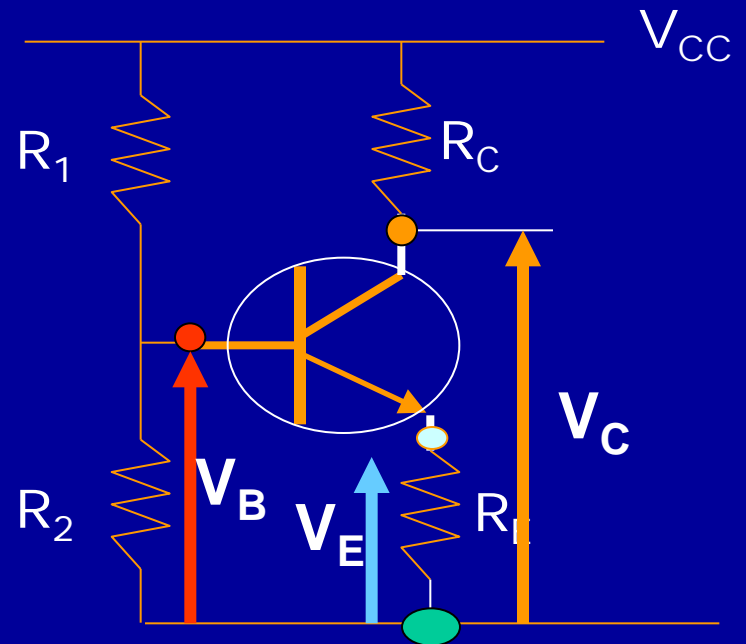

$$V_{CE} = V_{CC} - \beta I_B (R_C + R_E)$$

$$V_C = V_{CC} - I_C R_C$$

$$V_B = V_{BE} + V_E$$

$$V_E = I_E R_E$$

TRANSISTOR NPN

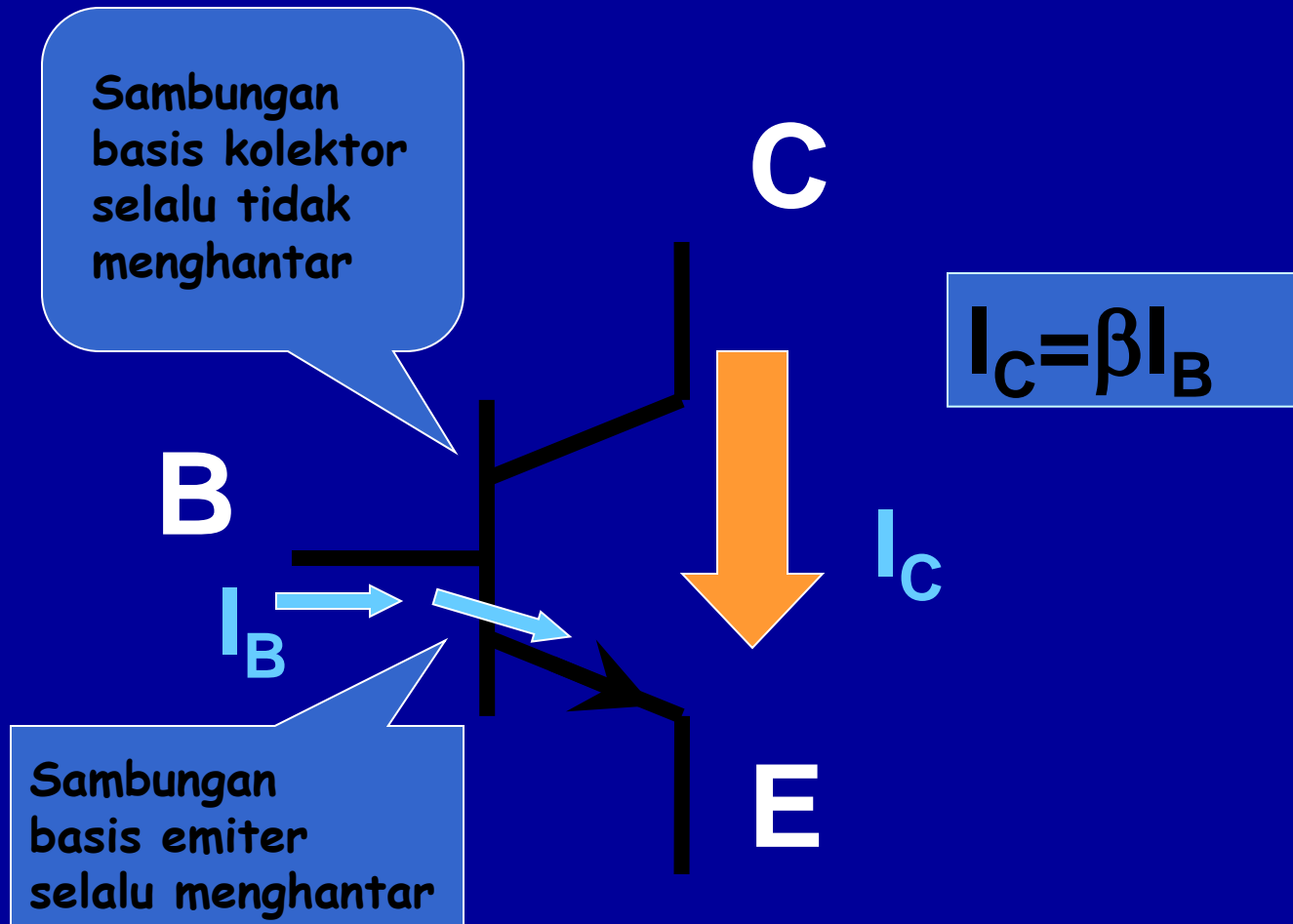

TRANSISTOR PNP

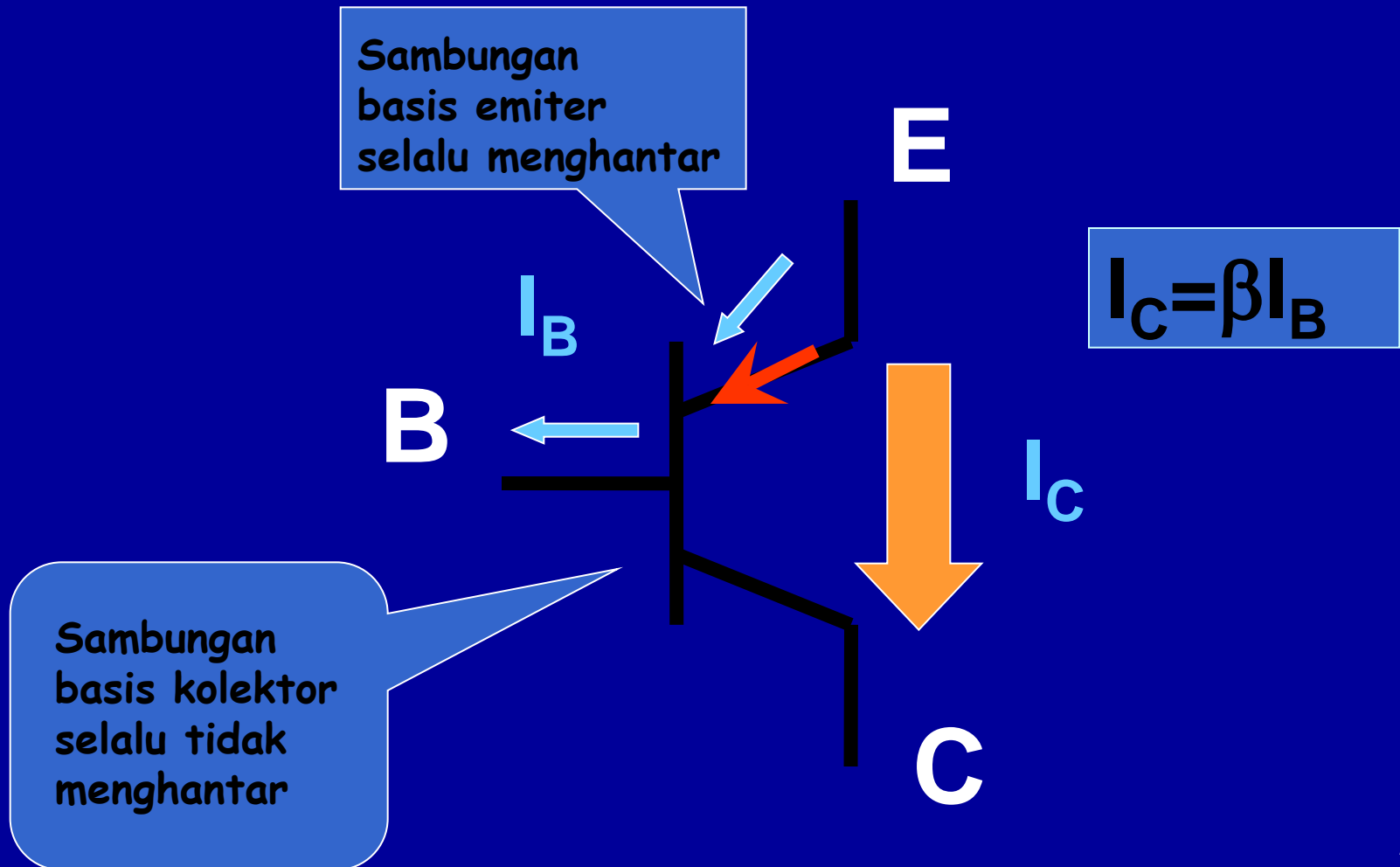

TITIK KERJA

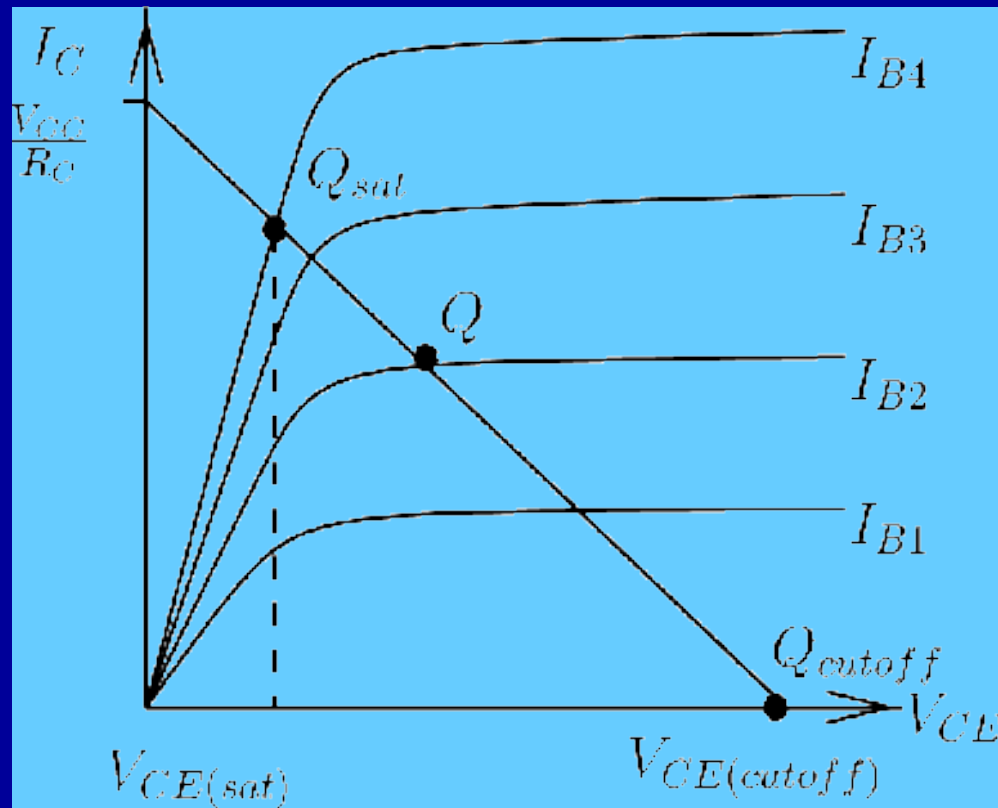

TITIK KERJA DAN GARIS KERJA

Q point dan Load Line

V_{CC} tetap, R_C berubah, I_B tetap

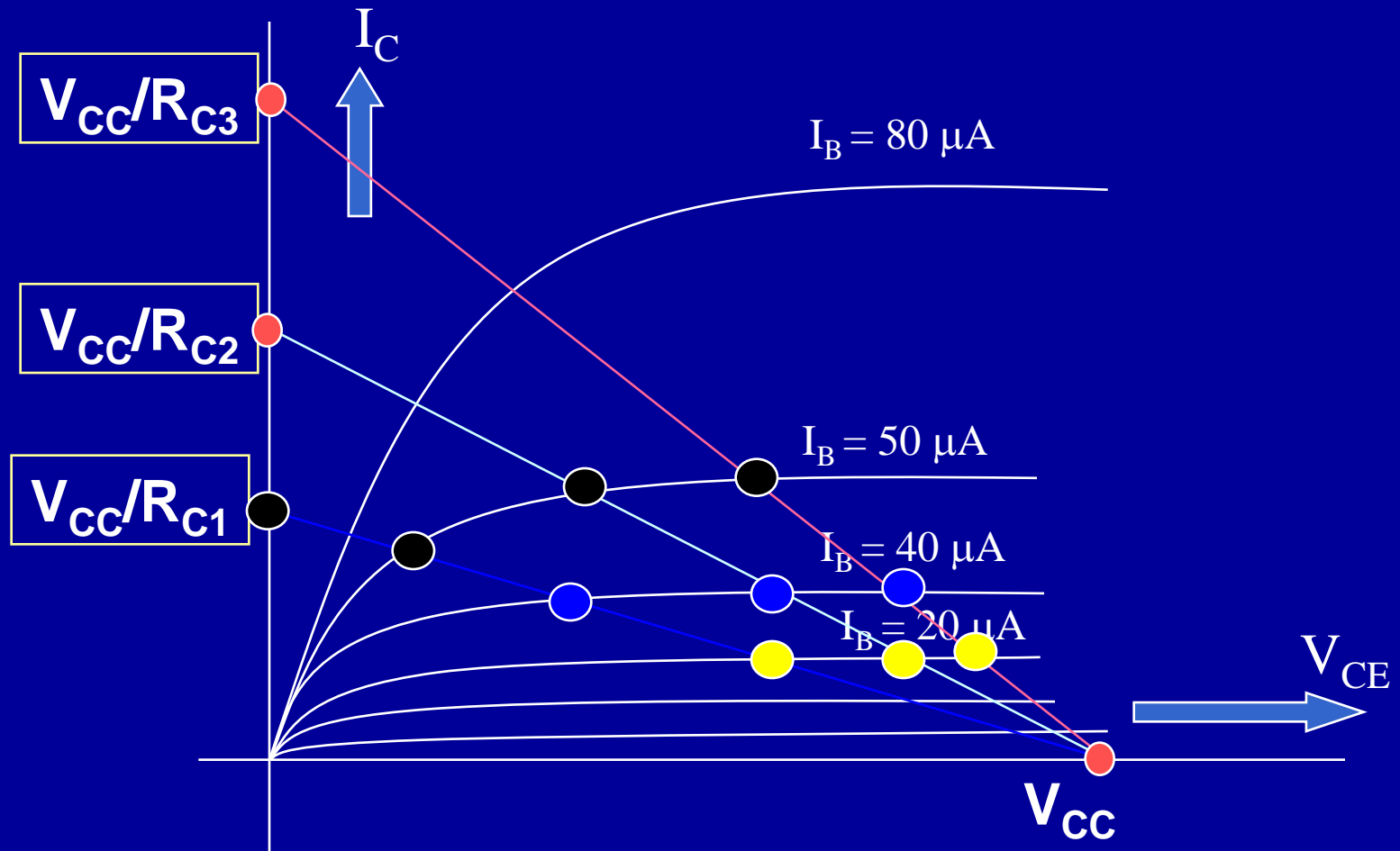

TITIK KERJA TRANSISTOR

VCC berubah, RC tetap

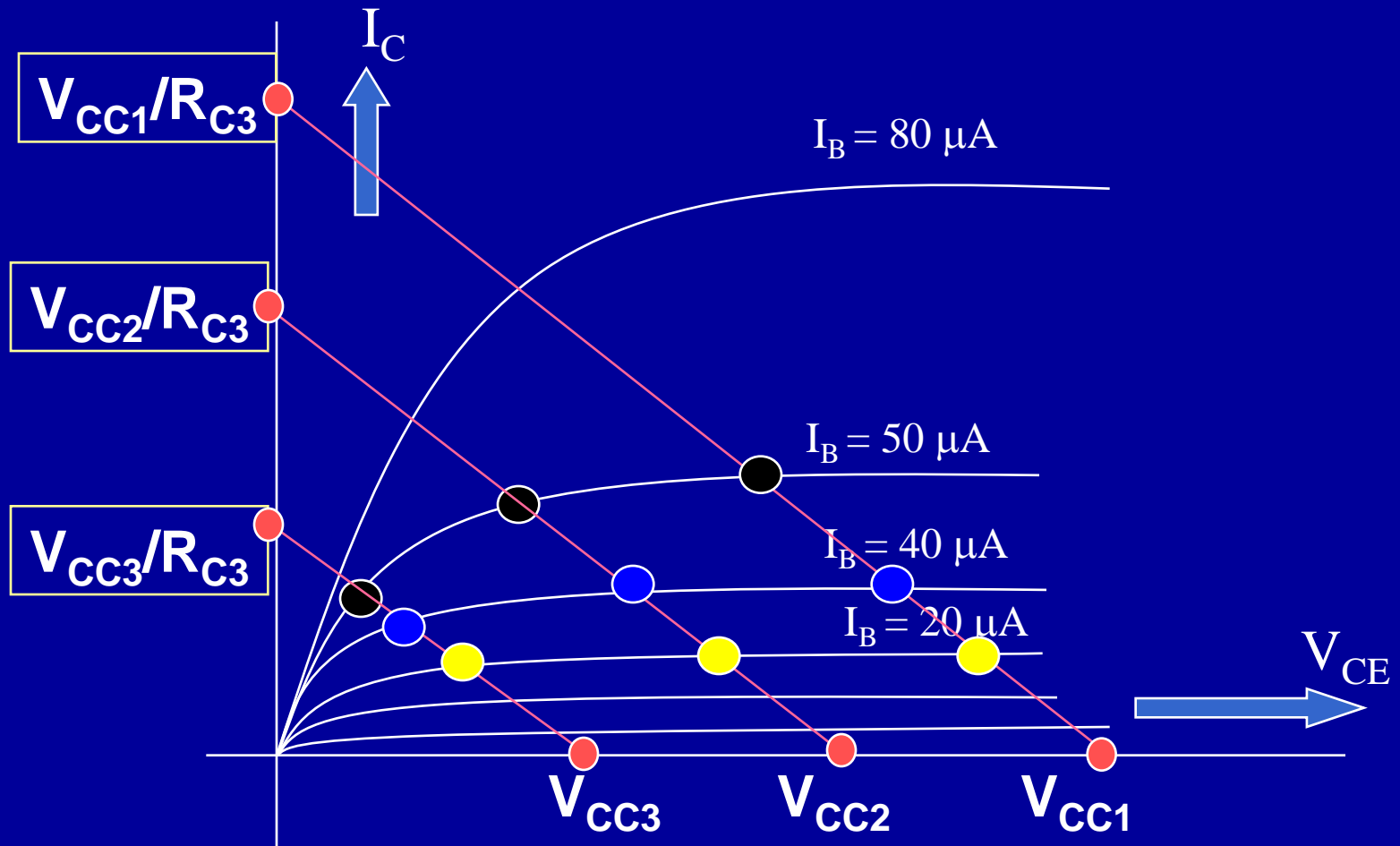

Daerah Kerja

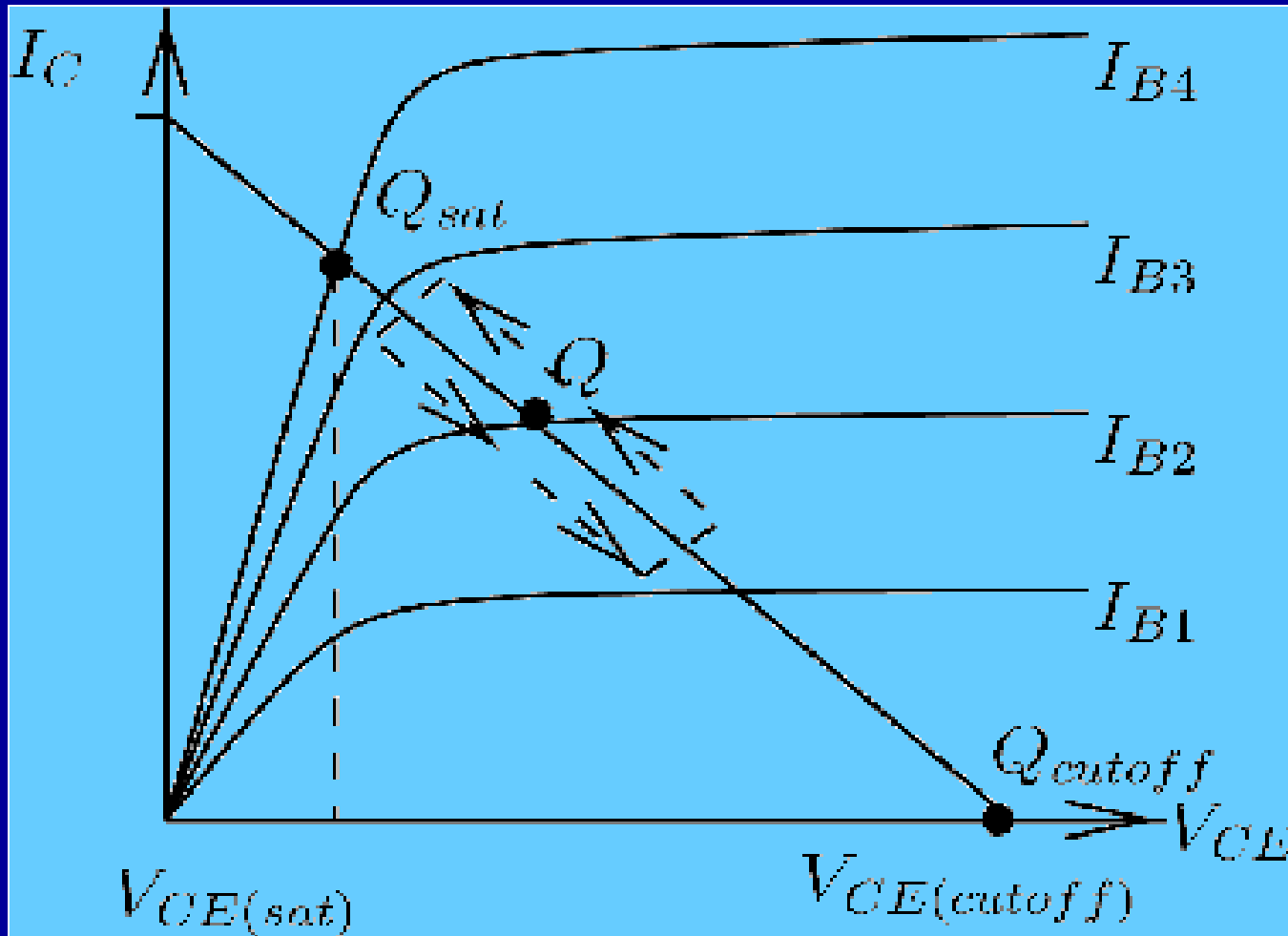

Lanjutan Transistor

- Macam – Macam Transistor
- Jenis – Jenis Transistor
- Bentuk Transistor
- Pengujian Transistor

TRANSISTOR

Table 1a.

Transistors

	Type	U_{ceo} (max)	I_c (max)	h_{fe} (min)	P_{tot} (max)	f_T (min)
TUN	NPN	20Volt	0.1 Amp	100	0.1 Watt	100 Mhz
TUP	PNP	20Volt	0.1 Amp	100	0.1 Watt	100 Mhz

JENIS TRANSISTOR

Table 2.			Table 3.		
TUN	(NPN)		TUP	(PNP)	
BC107	BC208	BC384	BC157	BC253	BC416
BC108	BC209	BC407	BC158	BC261	BC417
BC109	BC237	BC408	BC159	BC262	BC418
BC147	BC238	BC409	BC177	BC263	BC419
BC148	BC239	BC413	BC178	BC307	BC512
BC149	BC317	BC414	BC179	BC308	BC513
BC171	BC318	BC547	BC204	BC309	BC514
BC172	BC319	BC548	BC205	BC320	BC557
BC173	BC347	BC549	BC206	BC321	BC558
BC182	BC348	BC582	BC212	BC322	BC559
BC183	BC349	BC583	BC213	BC350	
BC184	BC382	BC584	BC214	BC351	
BC207	BC383		BC251	BC352	
			BC252	BC415	

Table 6.

	NPN		PNP	
	BC107		BC177	
	BC108		BC178	
	BC109		BC179	
U_{ceo} (max)	45 V	45 V	45 V	45 V
	20 V	25 V	25 V	25 V
	20 V	20 V	20 V	20 V
U_{ebo} (max)	6 V	5 V	5 V	5 V
	5 V	5 V	5 V	5 V
	5 V	5 V	5 V	5 V
I_C (max)	100 mA	100 mA	100 mA	100 mA
	100 mA	100 mA	100 mA	100 mA
	100 mA	50 mA	50 mA	50 mA
P_{tot} (max)	300 mW	300 mW	300 mW	300 mW
	300 mW	300 mW	300 mW	300 mW
	300 mW	300 mW	300 mW	300 mW
f_T (min)	150 Mhz	130 Mhz	130 Mhz	130 Mhz
	150 Mhz	130 Mhz	130 Mhz	130 Mhz
	150 Mhz	130 Mhz	130 Mhz	130 Mhz
F (max)	10 dB	10 dB	10 dB	10 dB
	10 dB	10 dB	10 dB	10 dB
	4 dB	4 dB	4 dB	4 dB











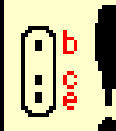
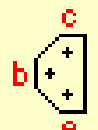

(A), (B) or (C) added to transistor type:

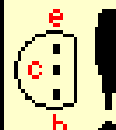
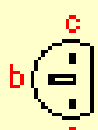
(A) = hfe 125 to 260

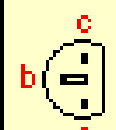
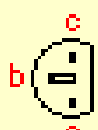
(B) = hfe 240 to 500

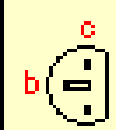
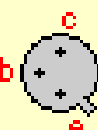
(C) = hfe 450 to 900

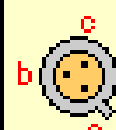
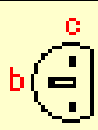
BENTUK TRANSISTOR

Table 5. Row 1			Row 2			Row 3		
NPN	PNP	Case Note	NPN	PNP	Case Note	NPN	PNP	Case Note
BC107 BC108 BC109	BC177 BC178 BC179		BC317 BC318 BC319	BC320 BC321 BC322	 $I_{c\max} = 150\text{ mA}$	BC467 BC468 BC469		 $P_{\max} = 220\text{ mW}$
BC147 BC148 BC149	BC157 BC158 BC159	 $P_{\max} = 250\text{ mW}$	BC347 BC348 BC349	BC350 BC351 BC352		BC167 BC168 BC169	BC257 BC258 BC259	 100/250: $I_{c\max} = 50\text{ mA}$
BC171 BC172 BC173	BC251 BC252 BC253	 251...253 Noise Free	BC382 BC383 BC384			BC547 BC548 BC549	BC557 BC558 BC559	 $P_{\max} = 500\text{ mW}$
BC182 BC183 BC184	BC212 BC213 BC214	 $I_{c\max} = 150\text{ mA}$	BC407 BC408 BC409	BC417 BC418 BC419	 $P_{\max} = 250\text{ mW}$	BC582 BC583 BC584	BC512 BC513 BC514	 $I_{c\max} = 200\text{ mA}$
BC207 BC208 BC209	BC204 BC205 BC206		BC413 BC414	BC415 BC416	 Noise Free		BC261 BC262 BC263	 Noise Free
BC237 BC238 BC239	BC307 BC308 BC309		BC437 BC438 BC439		 $P_{\max} = 220\text{ mW}$			

PENGUJIAN TRANSISTOR dengan multimeter

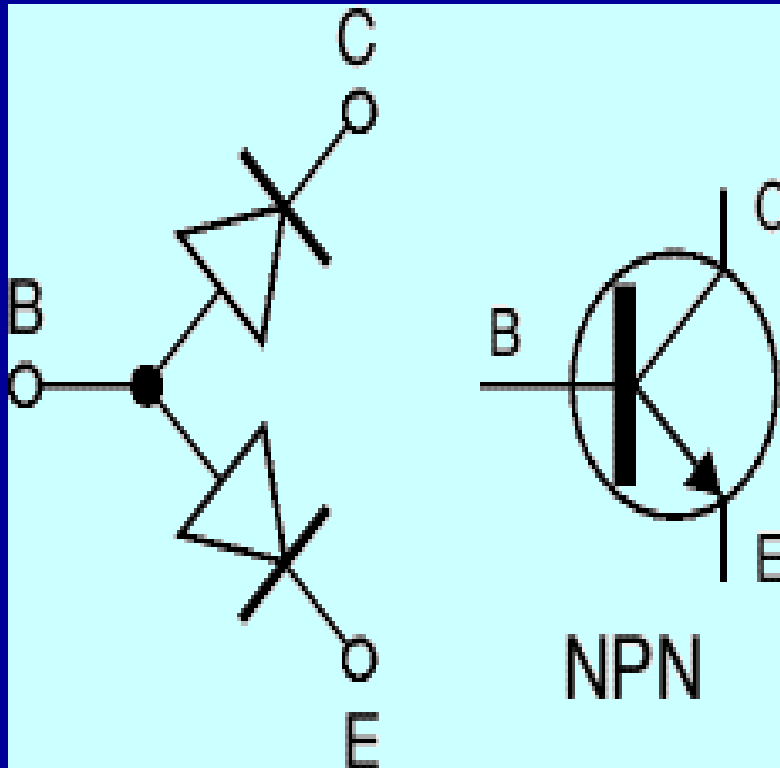

- **Sambungan Basis-Emitor (BE)** hanya menghantar satu arah.
- **Sambungan Basis –kolektor (BC)** hanya menghantar satu arah.
- **Sambungan Kolektor Emitor (CE)** sama sekali tidak menghantar dalam arah manapun.

PENGUJIAN TRANSISTOR dengan rangkaian

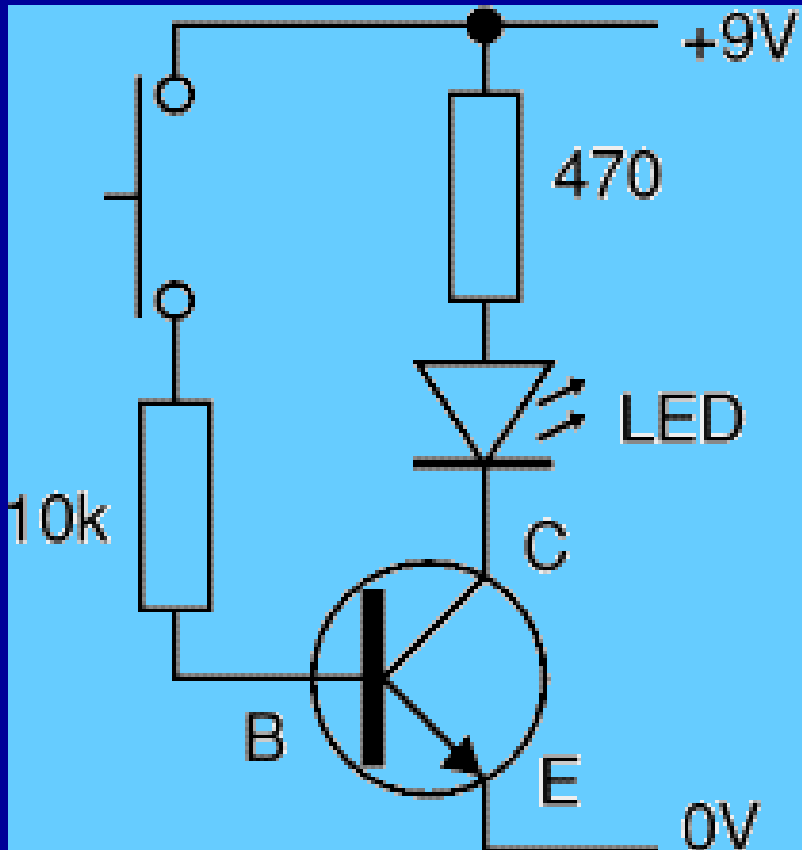

- Transistor baik bila :
- saklar ditekan LED menyala
- saklar dilepas LED mati.

KODE TRANSISTOR

Kode mulai huruf B (atau A), contoh BC108, BC478

Huruf pertama : **B = silicon, A = germanium (jarang ada)**.

Huruf kedua :
C = low power audio frequency;
D = high power audio frequency;
F = low power high frequency.

Sisa nomer jenis tertentu

Huruf berikutnya (kalau ada) menunjukkan hfe

A= hfe rendah

B = hfe menengah

C = hfe tinggi

KODE TRANSISTOR

Kode dimulai TIP, misal TIP31A

TIP = pabrik : Texas Instruments Power transistor.

Nomer ganjil : NPN,

Nomer genap : PNP.

Terakhir : versi untuk tegangan yang berbeda.

Kode dimulai 2N, misalnya 2N3053

2N identifies the part as a transistor and the rest of the code identifies the particular transistor. There is no obvious logic to the numbering system.

PEMILIHAN TRANSISTOR

1. The most important properties to look for are the maximum **collector current I_C** and the **current gain H_{fe}** .
2. To make selection easier most suppliers group their transistors in categories determined either by their **typical use** or **maximum power** rating.

TRANSISTOR

NPN transistors								
Code	Structure	Case style	$I_{c\ max}$	$V_{CE\ max}$	$h_{FE\ min}$	$P_{tot\ max}$	Category (typical use)	Possible substitutes
BC107	NPN	TO18	100mA	45V	110	300mW	Audio, low power	BC182 BC547
BC108	NPN	TO18	100mA	20V	110	300mW	General purpose, low power	BC108C BC183 BC548
BC108C	NPN	TO18	100mA	20V	420	600mW	General purpose, low power	
BC109	NPN	TO18	200mA	20V	200	300mW	Audio (low noise), low power	BC184 BC549
2N3053	NPN	TO39	700mA	40V	50	500mW	General purpose, low power	BFY51
BFY51	NPN	TO39	1A	30V	40	800mW	General purpose, medium power	BC639
BC639	NPN	TO92A	1A	80V	40	800mW	General purpose, medium power	BFY51
TIP29A	NPN	TO220	1A	60V	40	30W	General purpose, high power	
TIP31A	NPN	TO220	3A	60V	10	40W	General purpose, high power	TIP31C TIP41A
TIP31C	NPN	TO220	3A	100V	10	40W	General purpose, high power	TIP31A TIP41A
TIP41A	NPN	TO220	6A	60V	15	65W	General purpose, high power	
2N3055	NPN	TO3	15A	60V	20	117W	General purpose, high power	

TRANSISTOR DARLINGTON

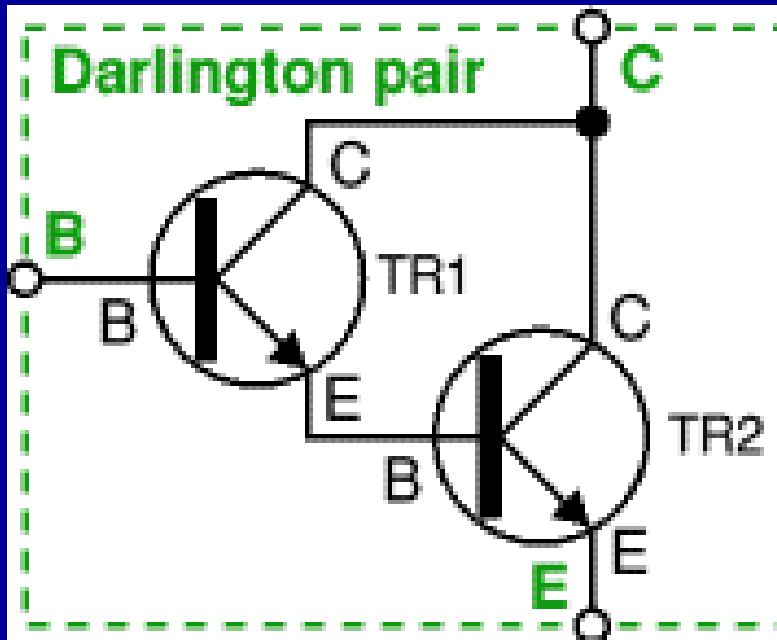

- Kedua transistor disambung seperti tergambar.
- Penguatan arus total adalah perkalian antara penguatan kedua transistor.
- Gain transistor Darlington bisa mencapai **10000**.
- Transistor Darlington dijual dalam kemasan seperti transistor biasa dengan tiga kaki (**B**, **C** and **E**).

SYMBOL	PARAMETER	CONDITIONS	MIN.	TYP.	MAX.	UNIT
I_{CBO}	collector cut-off current	$I_E = 0; V_{CB} = 20 \text{ V}$	–	–	15	nA
		$I_E = 0; V_{CB} = 20 \text{ V}; T_J = 150 \text{ }^\circ\text{C}$	–	–	15	μA
I_{EBO}	emitter cut-off current	$I_C = 0; V_{EB} = 5 \text{ V}$	–	–	50	nA
h_{FE}	DC current gain BC107A; BC108A BC107B; BC108B; BC109B BC108C; BC109C	$I_C = 10 \text{ } \mu\text{A}; V_{CE} = 5 \text{ V}$	–	90	–	
			40	150	–	
			100	270	–	
h_{FE}	DC current gain BC107A; BC108A BC107B; BC108B; BC109B BC108C; BC109C	$I_C = 2 \text{ mA}; V_{CE} = 5 \text{ V}$	110	180	220	
			200	290	450	
			420	520	800	
V_{CEsat}	collector-emitter saturation voltage	$I_C = 10 \text{ mA}; I_B = 0.5 \text{ mA}$	–	90	250	mV
		$I_C = 100 \text{ mA}; I_B = 5 \text{ mA}$	–	200	600	mV
V_{BEsat}	base-emitter saturation voltage	$I_C = 10 \text{ mA}; I_B = 0.5 \text{ mA}; \text{note 1}$	–	700	–	mV
		$I_C = 100 \text{ mA}; I_B = 5 \text{ mA}; \text{note 1}$	–	900	–	mV
V_{BE}	base-emitter voltage	$I_C = 2 \text{ mA}; V_{CE} = 5 \text{ V}; \text{note 2}$	550	620	700	mV
		$I_C = 10 \text{ mA}; V_{CE} = 5 \text{ V}; \text{note 2}$	–	–	770	mV
C_c	collector capacitance	$I_E = I_C = 0; V_{CB} = 10 \text{ V}; f = 1 \text{ MHz}$	–	2.5	6	pF
C_e	emitter capacitance	$I_C = I_E = 0; V_{EB} = 0.5 \text{ V}; f = 1 \text{ MHz}$	–	9	–	pF
f_T	transition frequency	$I_C = 10 \text{ mA}; V_{CB} = 5 \text{ V}; f = 100 \text{ MHz}$	100	–	–	MHz
F	noise figure BC109B; BC109C	$I_C = 200 \text{ } \mu\text{A}; V_{CE} = 5 \text{ V}; R_B = 2 \text{ k}\Omega;$ $f = 30 \text{ Hz to } 15.7 \text{ kHz}$	–	–	4	dB
			–	–	–	–
F	noise figure BC107A; BC108A BC107B; BC108B; BC108C BC109B; BC109C	$I_C = 200 \text{ } \mu\text{A}; V_{CE} = 5 \text{ V}; R_B = 2 \text{ k}\Omega;$ $f = 1 \text{ kHz}; B = 200 \text{ Hz}$	–	–	10	dB
			–	–	–	–
			–	–	4	dB

Data sheet

SYMBOL	PARAMETER	CONDITIONS	MIN.	TYP.	MAX.	UNIT
I_{CBO}	collector cut-off current	$I_E = 0; V_{CB} = 20 \text{ V}$	–	–	15	nA
		$I_E = 0; V_{CB} = 20 \text{ V}; T_j = 150 \text{ }^\circ\text{C}$	–	–	15	μA
I_{EBO}	emitter cut-off current	$I_C = 0; V_{EB} = 5 \text{ V}$	–	–	50	nA
h_{FE}	DC current gain BC107A; BC108A BC107B; BC108B; BC109B BC108C; BC109C	$I_C = 10 \text{ } \mu\text{A}; V_{CE} = 5 \text{ V}$	–	90	–	
			40	150	–	
			100	270	–	
h_{FE}	DC current gain BC107A; BC108A BC107B; BC108B; BC109B BC108C; BC109C	$I_C = 2 \text{ mA}; V_{CE} = 5 \text{ V}$	110	180	220	
			200	290	450	
			420	520	800	
V_{CEsat}	collector-emitter saturation voltage	$I_C = 10 \text{ mA}; I_B = 0.5 \text{ mA}$	–	90	250	mV
		$I_C = 100 \text{ mA}; I_B = 5 \text{ mA}$	–	200	600	mV
V_{BEsat}	base-emitter saturation voltage	$I_C = 10 \text{ mA}; I_B = 0.5 \text{ mA}; \text{note 1}$	–	700	–	mV
		$I_C = 100 \text{ mA}; I_B = 5 \text{ mA}; \text{note 1}$	–	900	–	mV
V_{BE}	base-emitter voltage	$I_C = 2 \text{ mA}; V_{CE} = 5 \text{ V}; \text{note 2}$	550	620	700	mV
		$I_C = 10 \text{ mA}; V_{CE} = 5 \text{ V}; \text{note 2}$	–	–	770	mV
C_c	collector capacitance	$I_E = I_e = 0; V_{CB} = 10 \text{ V}; f = 1 \text{ MHz}$	–	2.5	6	pF
C_e	emitter capacitance	$I_C = I_c = 0; V_{EB} = 0.5 \text{ V}; f = 1 \text{ MHz}$	–	9	–	pF
f_T	transition frequency	$I_C = 10 \text{ mA}; V_{CB} = 5 \text{ V}; f = 100 \text{ MHz}$	100	–	–	MHz

BC108 GP-Low Power

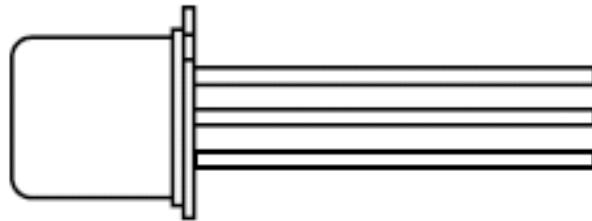
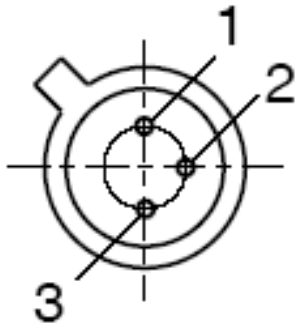
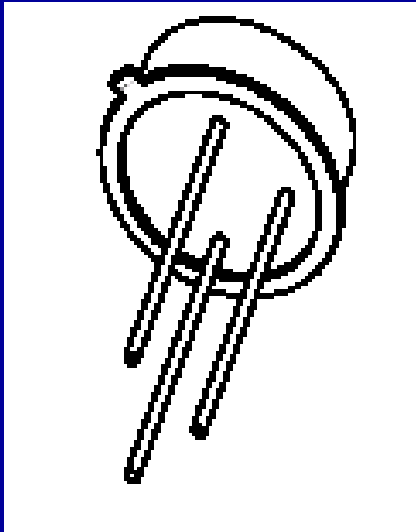

MAM264

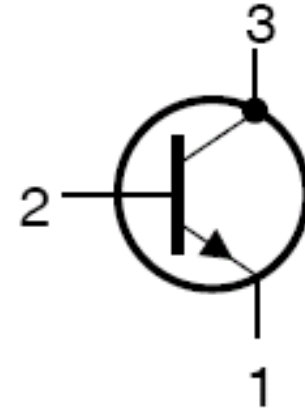
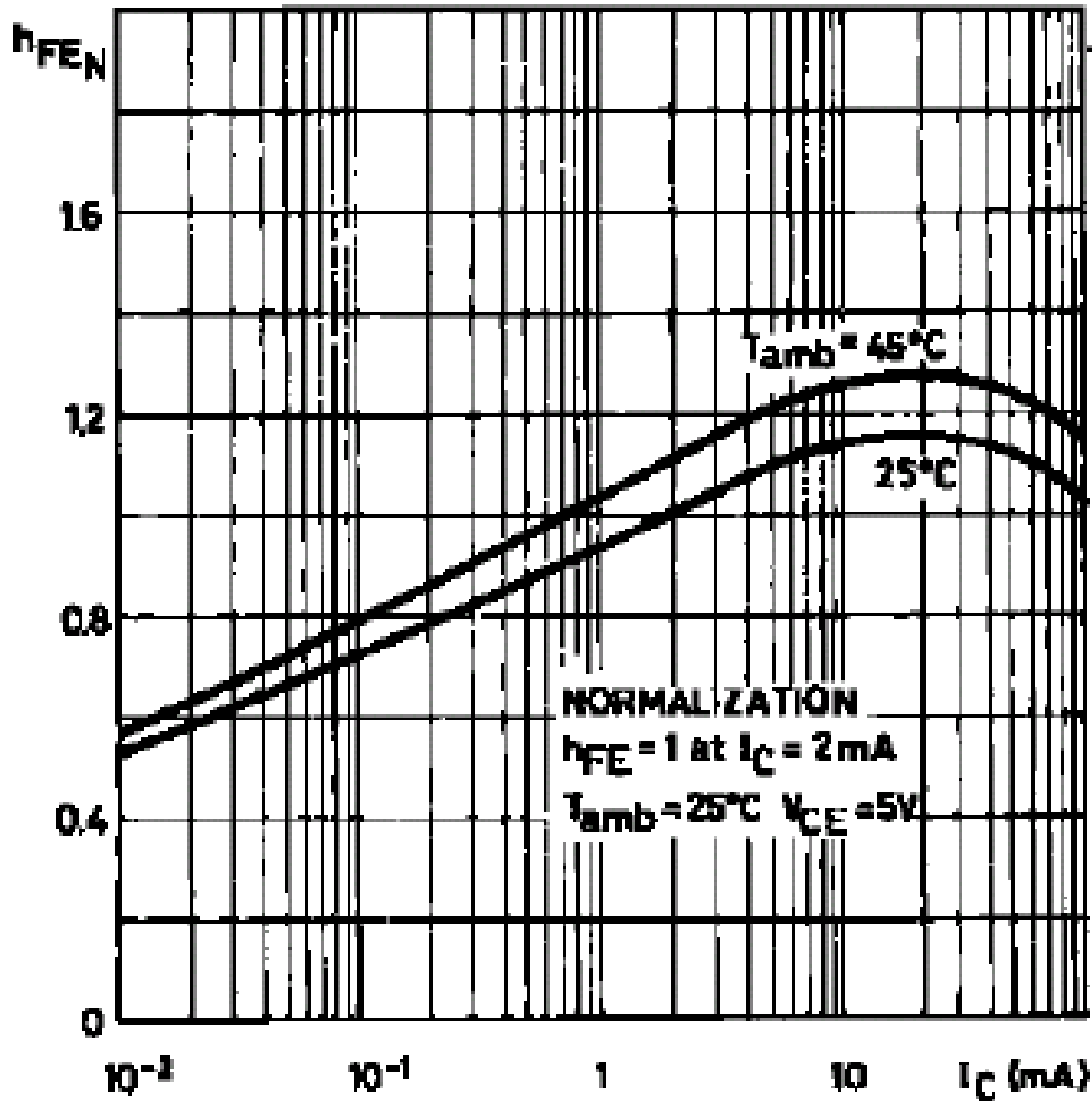
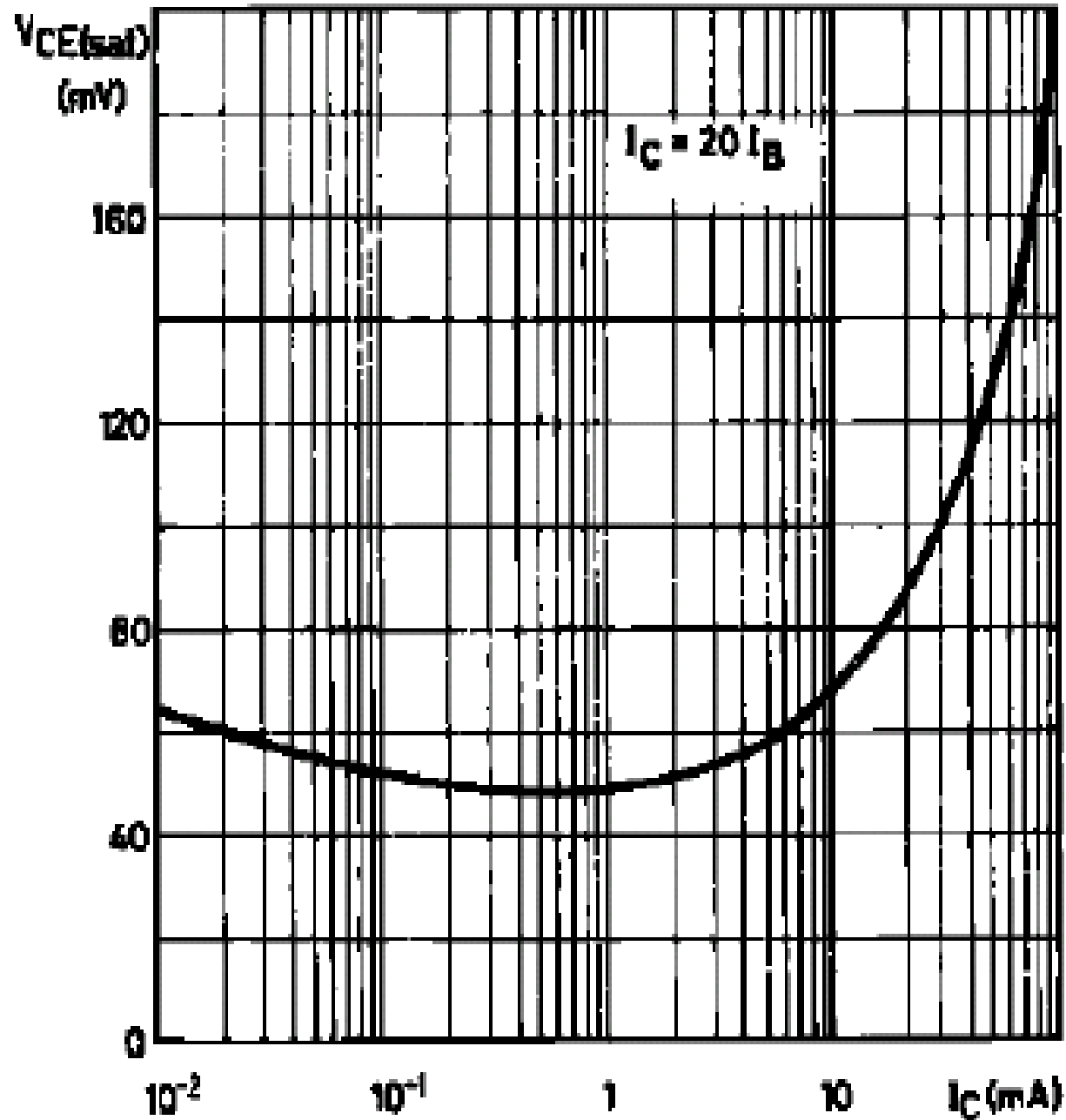

Fig.1 Simplified outline (TO-18; SOT18)
and symbol.

G-3216



Hfe tidak konstan, tetapi fungsi dari I_C



vce juga
ditentukan
oleh I_C

Transistor daya

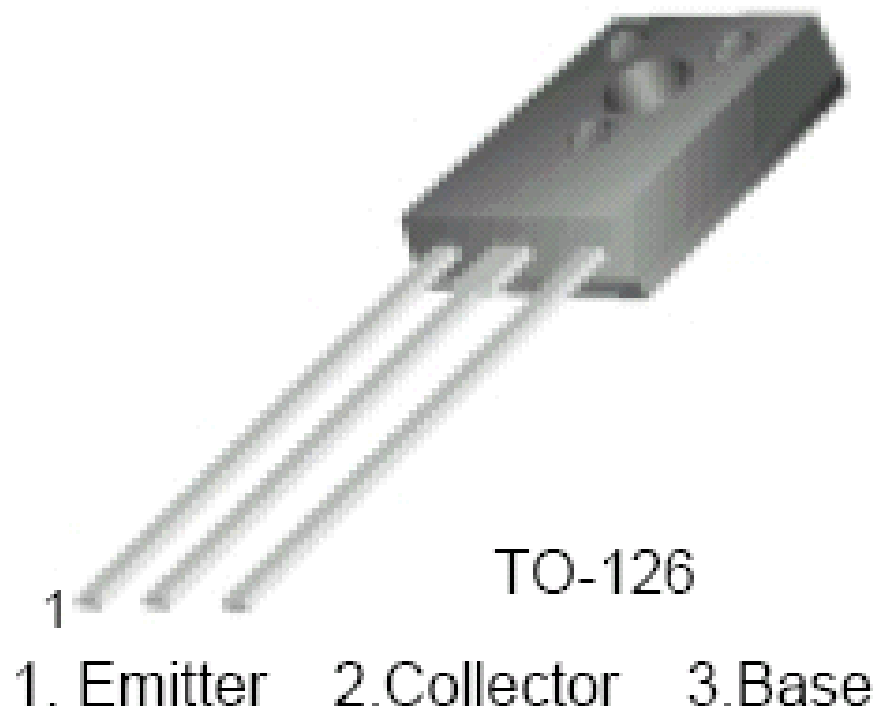

DC CURRENT GAIN

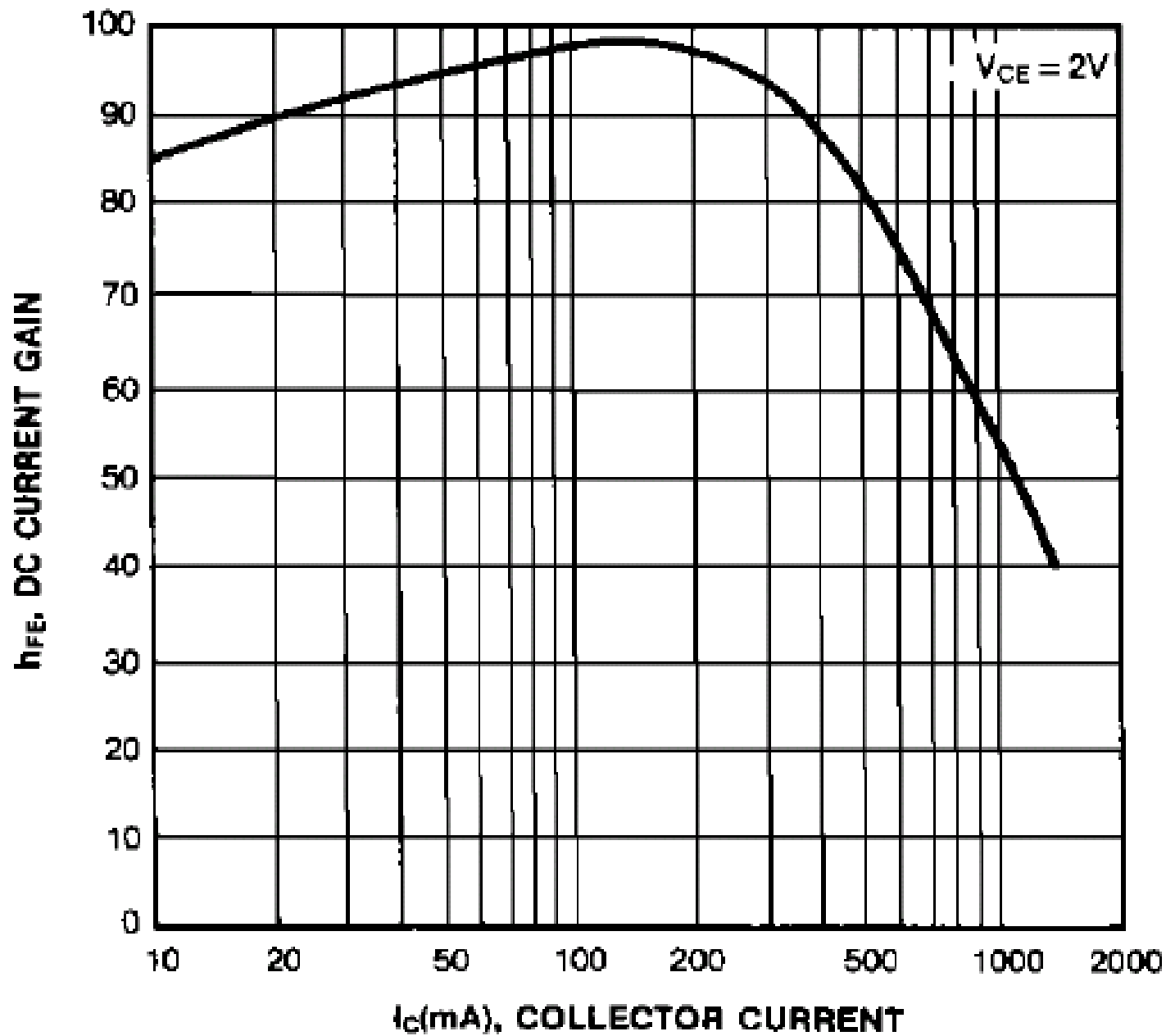

BASE EMITTER VOLTAGE

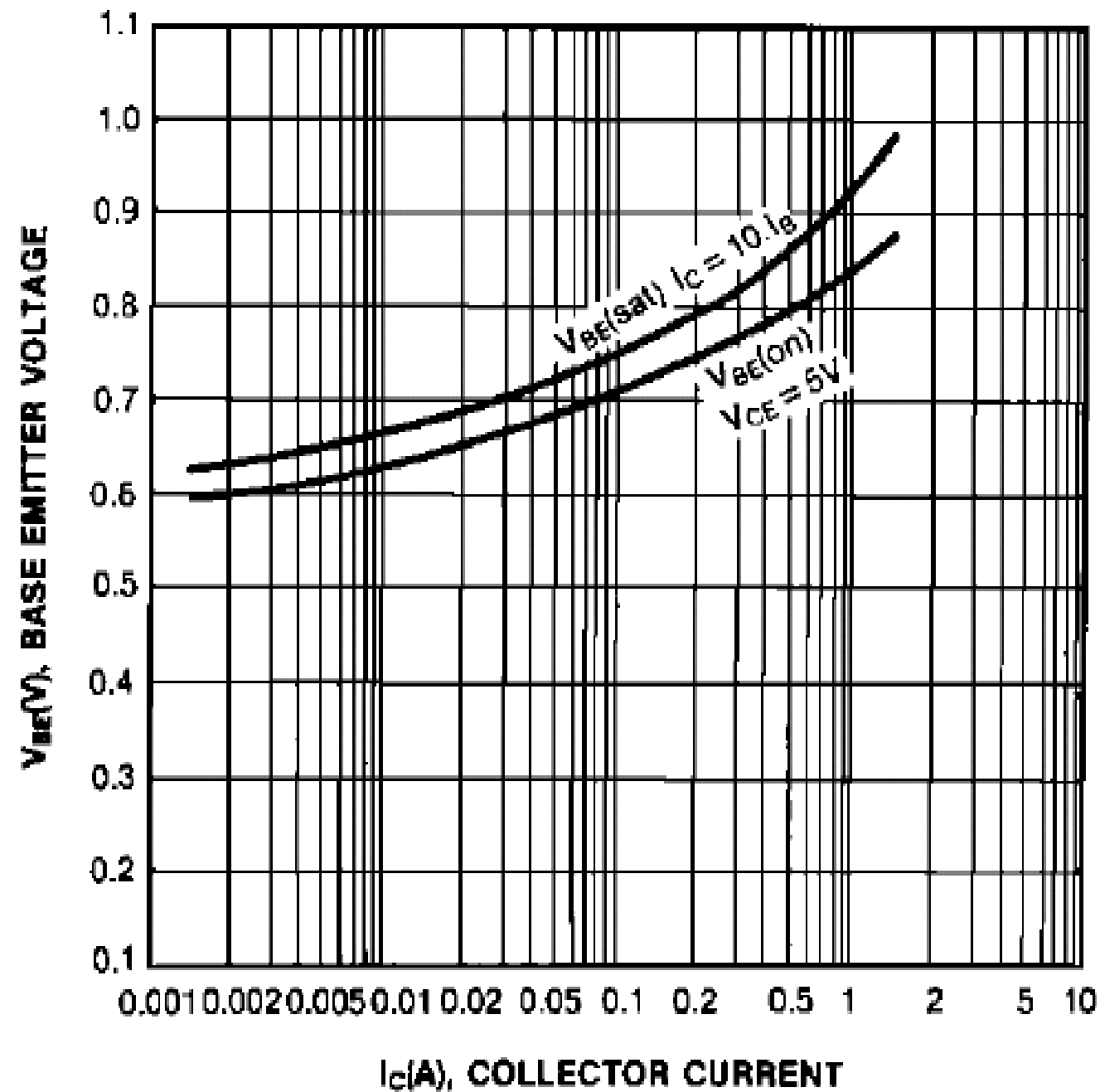

TITIK KERJA MEMENTUKAN KLAS AMPLIFIER

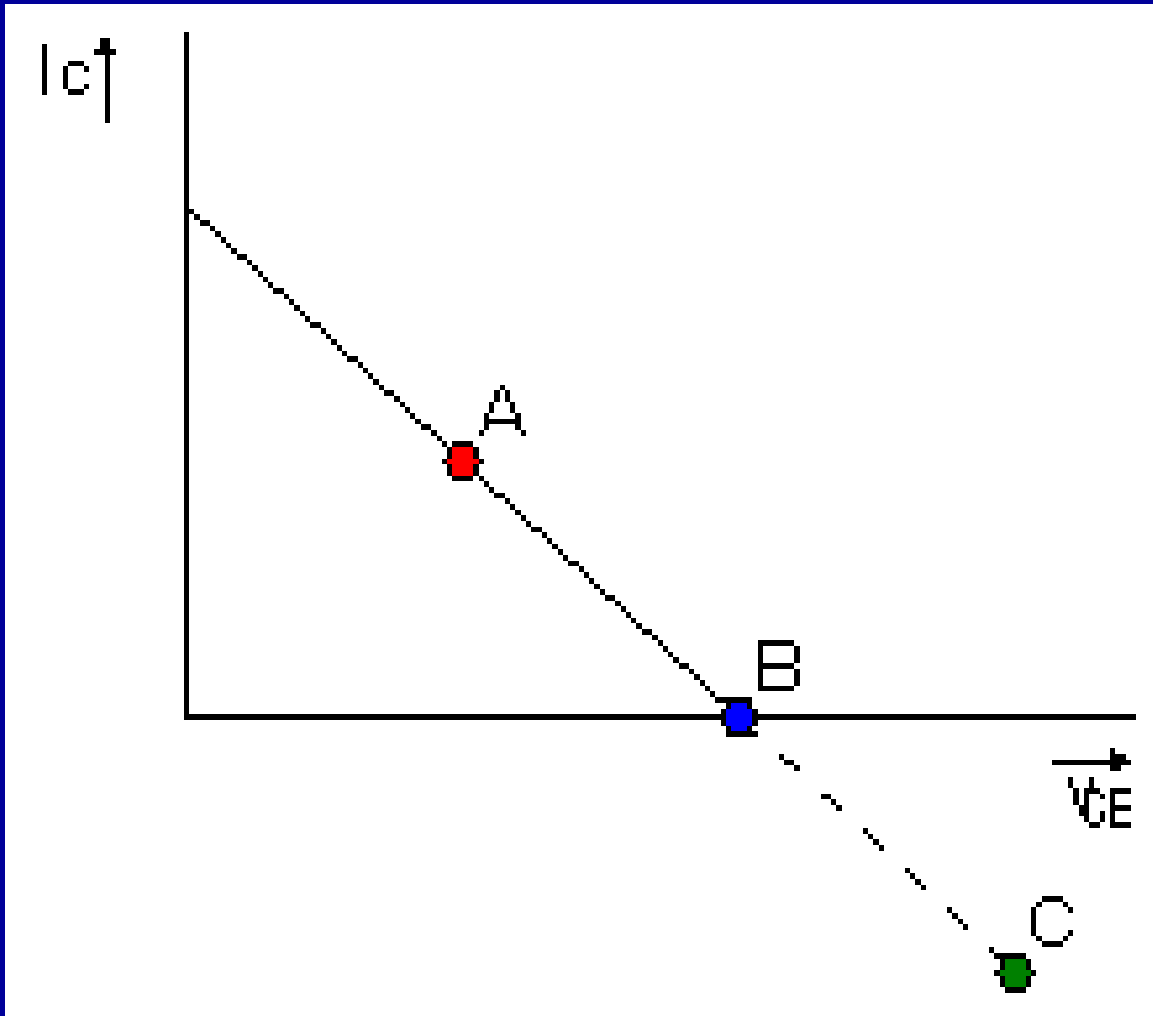

AMPLIFIER KLAS A

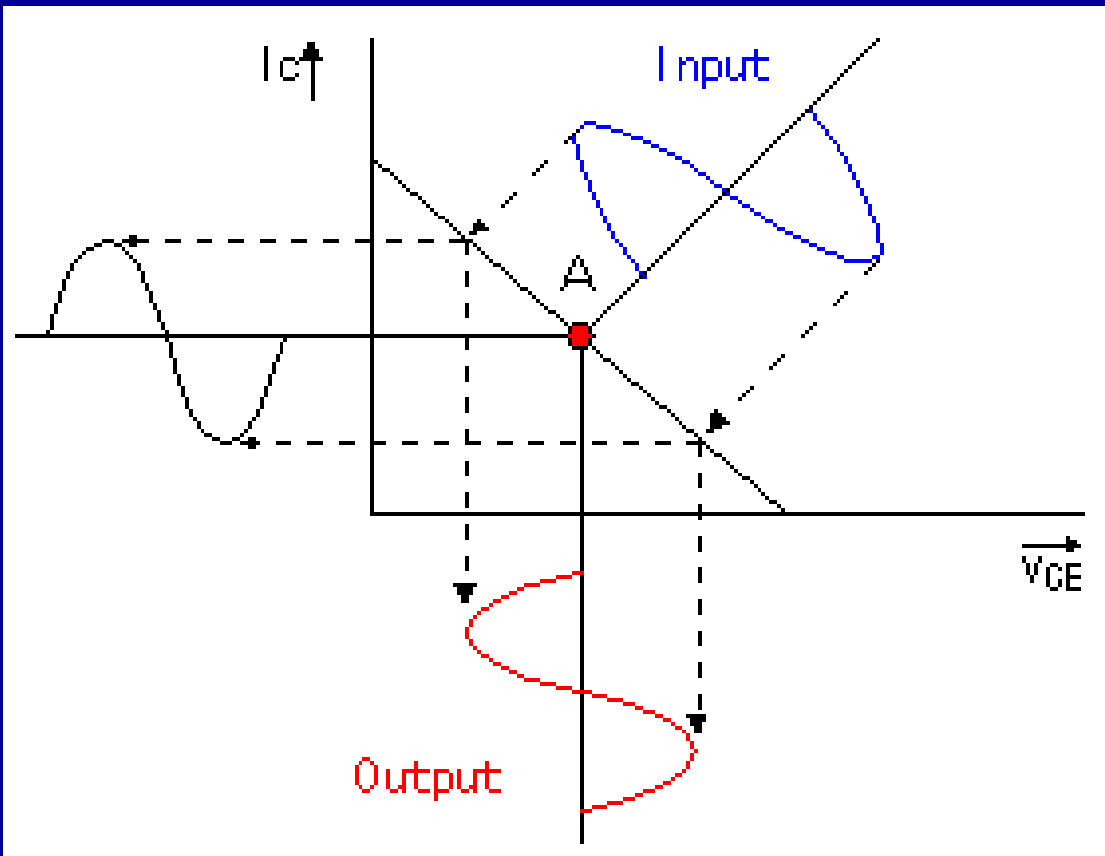

- Perhatikan
- bentuk gelombang output
- sama dengan
- bentuk gelombang input

Amplifier kelas B

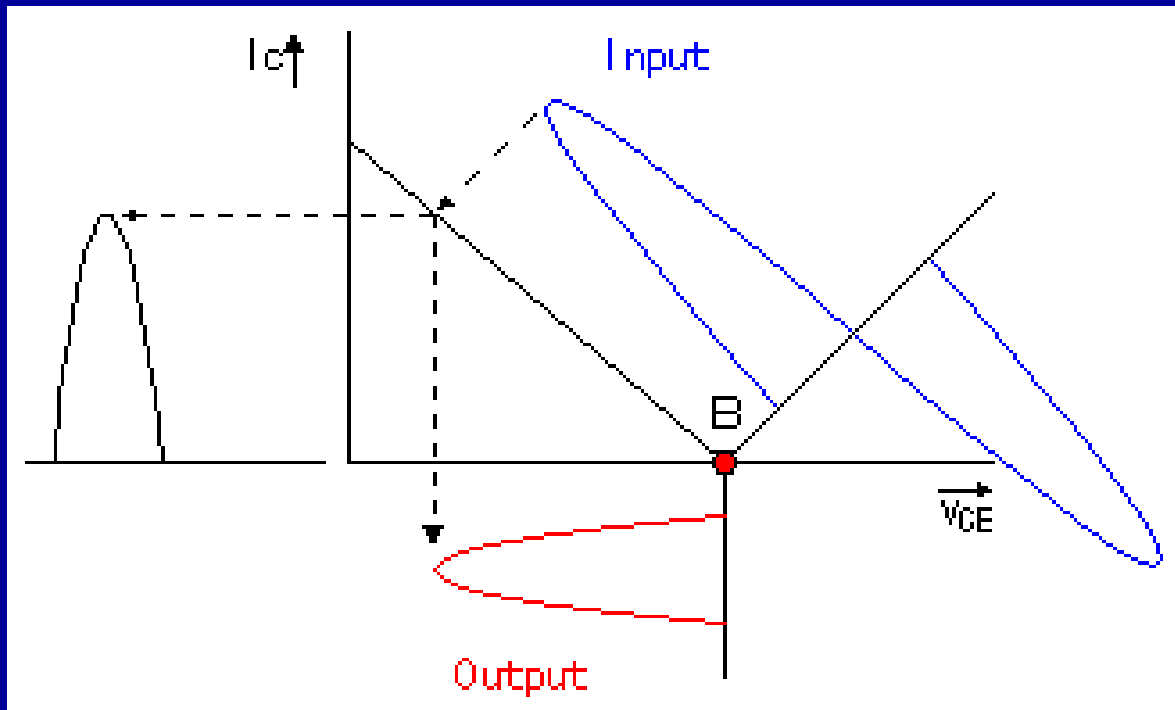

- Perhatikan
- Gelombang output
- hanya
- setengah gelombang input

Amplifier Kelas C

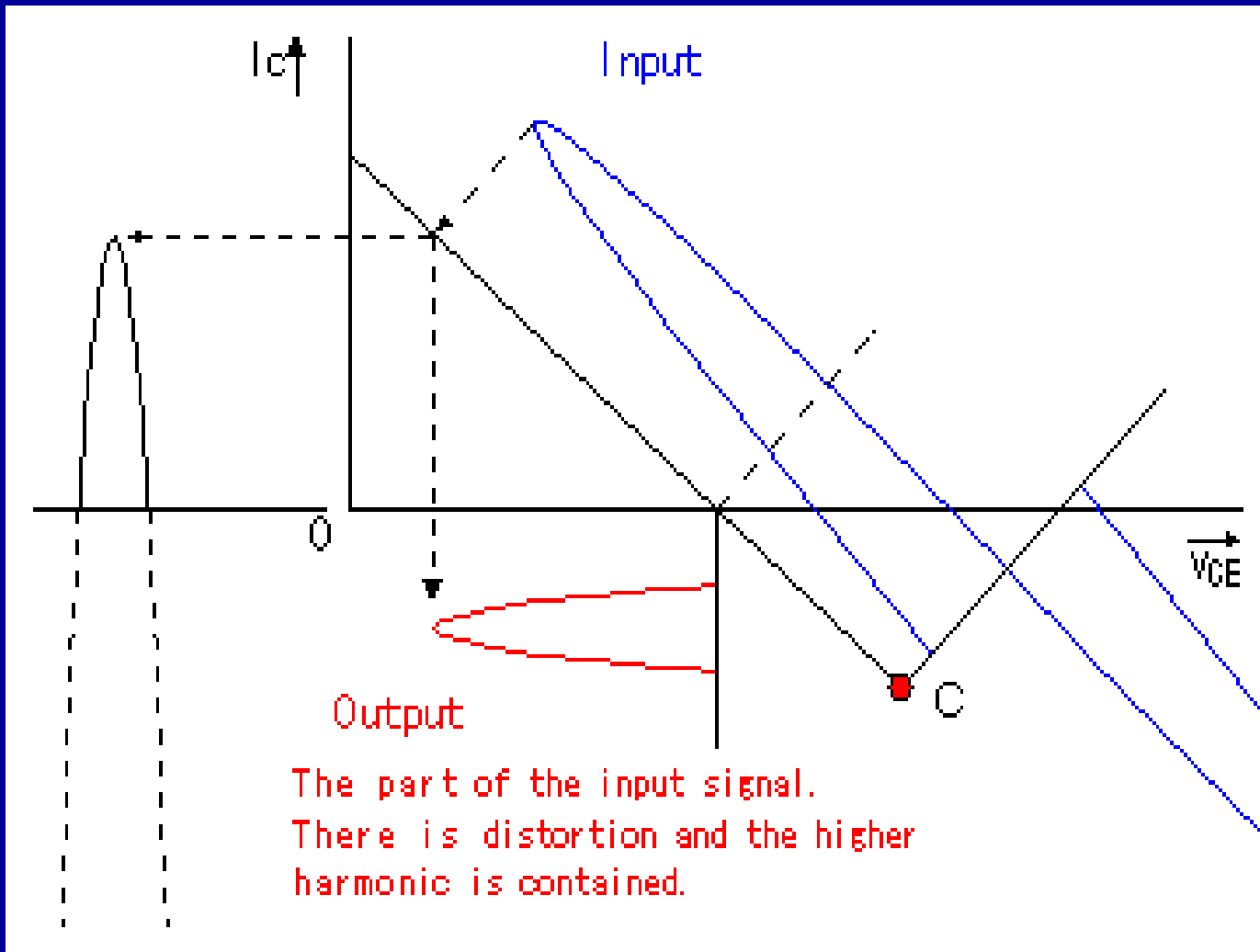

Tegangan Keluaran banyak harmonis