

BIDANG PENDIDIKAN DAN PENGAJARAN

BERITA ACARA PERKULIAHAN

KULIAH ONLINE/OFF LINE

(LEARNING)

PERIODE SEMESTER GANJIL 2023-2024

MATA KULIAH

PENGUNAAN MESIN LISTRIK

BERITA ACARA PERKULIAHAN

- 1. SK DEKAN FTI SEMESTER GANJIL 2023-2024***
- 2. PRESENSI KEHADIRAN DOSEN DAN MATERI AJAR***
- 3. NILAI KOMULATIF : KEHADIRAN, TUGAS, UTS DAN UAS***
- 4. CONTOH HAND OUT MATERI AJAR***

PROGRAM STUDI TEKNIK ELEKTROFAKULTAS

TEKNOLOGI INDUSTRI

**INSTITUT SAINS DAN TEKNOLOGI NASIONAL
2023/2024**



YAYASAN PERGURUAN CIKINI
INSTITUT SAINS DAN TEKNOLOGI NASIONAL

Jl. Moh. Kahfi II, Bhumi Srengseng Indah, Jagakarsa, Jakarta Selatan 12640
Telp. 021-7270090 (hunting), Fax. 021-7866955, hp: 081291030024
Email : humas@istn.ac.id Website : www.istn.ac.id

SURAT PENUGASAN TENAGA PENDIDIK

Nomor : 282 / 03.1 - G / IX / 2023

SEMESTER **GANJIL**, TAHUN AKADEMIK 2023 / 2024

Nama : Sugiarto,Ir,MT Status Pegawai : Edukatif Tetap / Tidak Tetap
NIK : 186489 Program Studi : Teknik Elektro
Jabatan Akademik : Lektor

Bidang	Perincian Kegiatan	Tempat	Jam/ Minggu	Kinerja (sks)	Keterangan	
I PENDIDIKAN Dan PENGAJARAN	MENGAJAR DI KELAS (KULIAH / RESPONSI DAN LABORATORIUM)					
	1.Penggunaan Mesin Listrik (A)			2	Senin,13.00-14.40	
	2.Teknologi Sistem Tenaga Listrik (Kls A)			2	Senin,08.00-09.40	
	3.Trasformator(Kls A)			2	Selasa, 10.00-11.40	
	4.Penggunaan Mesin Listrik (Kls K)			2	Selasa,19.00-20.40	
	5.Teknologi Sistem Tenaga Listrik (Kls K)			2	Sabtu, 10.00 - 11.40	
	6.Transformator (Klas K)			2	Sabtu, 08.00-09.40	
	7.				.	
	8.				.	
	9.				.	
	10.				.	
	11.				.	
	12.				.	
	13.				.	
	14.				.	
	15.				.	
	16.				.	
	17. Membimbing Skripsi / Tugas Akhir				1	
18. Menguji Skripsi / Tugas Akhir				1		
II PENELITIAN	1. Penelitian Ilmiah					
	2. Penulisan Karya Ilmiah			1		
	3. Penulisan Diktat Kuliah					
	4. Menerjemahkan Buku					
	5. Pembuatan Rancangan Teknologi					
	6. Pembuatan Rancangan & Karya Pertunjukan					
III PENGABDIAN DAN MASYARAKAT	1. Menduduki Jabatan di Pemerintahan					
	2. Pengembangan Hasil Pendidikan Dan Penelitian					
	3. Memberikan Penyuluhan/Pelatihan/Ceramah pada masyarakat				1	
	4. Memberikan Pelayanan Kepada Masyarakat Umum					
	5. Menulis Karya Pengabdian Pada Masyarakat yang tidak dipublikasikan					
	6. Komersial / Kesepakatan					
IV UNSUR-UNSUR PENUNJANG	1. Jabatan Struktural					
	2. Penasehat Akademik					
	3. Berperan serta aktif dalam pertemuan ilmiah / seminar					
	4. Pengembangan program kuliah / Kelompok Ilmu Elektro					
	5. Menjadi anggota panitia / Badan pada suatu Perguruan Tinggi					
	6. Menjadi anggota Badan Lembaga Pemerintah					
	7. Menjadi Anggota Organisasi Profesi					
	8. Mewakili PT / Lembaga Pemerintah duduk dalam Panitia antar Lembaga					
	9. Menjadi Anggota Delegasi Nasional ke Parlemen – Parlemen Internasional					
Jumlah Total				16		

Kepada yang bersangkutan akan diberikan gaji / honorarium sesuai dengan peraturan penggajian yang berlaku di Institut Sains dan Teknologi Nasional
Penugasan ini berlaku dari tanggal 25 September 2023 sampai dengan tanggal 31 Maret 2024



Jakarta, 3 Oktober 2023
Dekan,

(Dr. Mufirah Cahya F.T.S.Si.,M.Si.)









Tembusan :

1. Direktur Akademik – ISTN
2. Direktur Non Akademik – ISTN
3. Ka. Biro Sumber Daya Manusia – ISTN
4. Kepala Program Studi Fak.
5. Arsip



BERITA ACARA PERKULIAHAN
(PRESENTASI KEHADIRAN DOSEN)
SEMESTER GANJIL TAHUN AKADEMIK 2023/2024
PROGRAM STUDI TEKNIK ELEKTRO S.1 ISTN

Mata Kuliah	: PENGUNAAN MESIN LISTRIK	Semester	: 5
Dosen	: Ir. Sugianto, MT	SKS	: 2
Hari	: Selasa/Rabu	Kelas	: K
Jam	: 19:00-20:40	Ruang	:

No.	HARI/TANGGAL	MATERI KULIAH	JML MHS HADIR	TANDA TANGAN DOSEN
1.	Selasa, 26-09-2023	- INTRODUCTION/PREFACE - Lecture material - References/books	8	
2.	03-10-2023	JENIS-JENIS MESIN LISTRIK Mesin Listrik Statis dan Mesin Listrik Dinamis	8	
3.	Selasa, 10-10-2023	Rangkaian Ekuivalen Motor DC : - Separately Excited (Berpengutan Terpisah) - Shunt - Compound	8	
4.	Rabu 18-10-2023	DC Motor Starter Circuit	8	
5.	Rabu 25-10-2023	Contoh-contoh soal	8	
6.	Rabu 01-11-2023	Sistem Ward Leonard	8	
7.	Rabu 08-11-2023	Starter Dan Pengaturan Kecepatan Motor Induksi	8	
8.	Rabu 15-11-2023	UJIAN TENGAH SEMESTER	8	



**BERITA ACARA PERKULIAHAN
(PRESENTASI KEHADIRAN DOSEN)
SEMESTER GANJIL TAHUN AKADEMIK 2023/2024
PROGRAM STUDI TEKNIK ELEKTRO S.1 ISTN**

Mata Kuliah	: PENGUNAAN MESIN LISTRIK	Semester	: 5
Dosen	: Ir.Sugianto, M.T	SKS	: 2
Hari	: Selasa/Rabu	Kelas	: K
Jam	: 19:00-20:40	Ruang	:

No.	TANGGAL	MATERI KULIAH	JML MHS HADIR	TANDA TANGAN DOSEN
9.	Selasa, 28-11-2023	Aplikasi motor dc pada kendaraan motor, mobil dan peralatan lainnya, untuk pengaturan kecepatan dan starting motor.	8	
10.	Selasa, 5-12-2023	Motor stater dc sebagai proteksi untuk equipment, overload, dan pengontrolan pada kecepatan motor	8	
11.	Selasa, 12-12-2023	Menentukan arus starting motor dan tegangan induksi.	8	
12.	Selasa, 19-12-2023	Menentukan sleep motor, menghitung kecepatan synchron motor, karakteristik curva generator, motor terhadap kecepatan.	8	
13.	Selasa, 26-12-2023	Diagram aliran daya dan penjelasn daya2, torsi induksi dan torsi beban.	8	
14.	Selasa, 02-01-2024	Cara membalik putaran motor slip, menghitung efisiensi dan sistem operasi motor induksi	8	
15.	Selasa, 09-01-2024	Contoh2 soal dan kisi-kisi ujian akhir semester	8	
16.	Selasa, 16-01-2024	Ujian Akhir Semester (UAS) semester genjil 2023-2024	8	

Jakarta, Januari 2024

DOSEN PENGAJAR

(Sugianto Ir.MT)

DAFTAR NILAI

SEMESTER GANJIL REGULER TAHUN 2023/2024

Program Studi : Teknik Elektro S1

Matakuliah : Penggunaan Mesin Listrik

Kelas / Peserta : K

Perkuliahan : Kampus ISTN Bumi Srengseng P2K - Kelas

Dosen : Dr. Ir. H. Abdul Multi, MT

Hal. 1/1

No	NIM	N A M A	ABSEN	TUGAS	UTS	UAS	MODEL	PRESENTASI	NA	HURUF
			10%	15%	35%	40%	0%	0%		
1	23224301	Muhammad Rijal Cahyadi	100	80	70	80	0	0	78.5	A-
2	23224701	Muhammad Elvan Rafif Najiyah	100	80	71	80	0	0	78.85	A-
3	23224702	Mayharani Jasiska Dini Daud	100	80	80	90	0	0	86	A
4	23224703	Rio Fadhillah	100	80	77	90	0	0	84.95	A
5	23224704	Rusydan Siswantoro Galih Aji	100	80	80	80	0	0	82	A
6	23224707	Dimas Rahmat Prasetya	100	80	75	80	0	0	80.25	A
7	23224708	Syarif Maulana	100	80	50	80	0	0	71.5	B
8	23224712	Karina Trie Rizkikha	100	80	85	90	0	0	87.75	A

Rekapitulasi Nilai							
A	5	B+	0	C+	0	D+	0
A-	2	B	1	C	0	D	0
		B-	0	C-	0	E	0

Jakarta, 25 January 2024

Dosen Pengajar



Sugianto, Ir. MT

DC Motor Starter



6-6 DC MOTOR STARTERS

In order for a dc motor to function properly on the job, it must have some special control and protection equipment associated with it. The purposes of this equipment are

1. To protect the motor against damage due to short circuits in the equipment
2. To protect the motor against damage from long-term overloads
3. To protect the motor against damage from excessive starting currents
4. To provide a convenient manner in which to control the operating speed of the motor.

The first three of these functions will be discussed in this section, and the fourth function will be considered in Sec. 6.7.

DC Motor Problems on Starting

In order for a dc motor to function properly, it must be protected from physical damage during the starting period. At starting conditions, the motor is not turning, and so $E_A = 0$ V. Since the internal resistance of a normal dc motor is very low compared to its size (3 to 6 percent per unit for medium-sized motors), a *very* high current flows.

Consider, for example, the 50-hp 250-V motor in Example 6-1. The full-load current of this motor is less than 200 A, but the current on starting is

$$\begin{aligned} I_A &= \frac{V_T - E_A}{R_A} \\ &= \frac{250 \text{ V} - 0 \text{ V}}{0.06 \Omega} = 4167 \text{ A} \end{aligned}$$

This current is over 20 times the motor's rated full-load current. It is possible for a motor to be severely damaged by such currents, even if they only last for a moment.

A solution to the problem of excess current during starting is to insert a *starting resistor* in series with the armature to limit the current flow until E_A can build up to do the limiting. This resistor must not be in the circuit permanently, because it would result in excessive losses and would cause the motor's torque-speed characteristic to drop off excessively with an increase in load.

Therefore, a resistor must be inserted into the armature circuit to limit current flow at starting, and it must be removed again as the speed of the motor builds up. In modern practice, a starting resistor is made up of a series of pieces, each of which is removed from the motor circuit in succession as the motor speeds up, in order to limit the current in the motor to a safe value while never reducing it to too low a value for rapid acceleration.

Figure 6-23 shows a shunt motor with an extra starting resistor that can be cut out of the circuit in segments by the closing of the 1A, 2A, and 3A contacts. Two actions are necessary in order to make a working motor starter. One of them is to pick the size and number of resistor segments necessary in order to limit the starting current to its desired bounds. The second is to design a control circuit that shuts the resistor bypass contacts at the proper time to remove those parts of the resistor from the circuit.

Some older dc motor starters used a continuous starting resistor which was gradually cut out of the circuit by a person moving its handle. This type of starter had problems, as it largely depended on the person starting the motor not to move its handle too quickly or too slowly. If the resistance were cut out too quickly (before the motor could speed up enough), the resulting current flow would be too large. On the other hand, if the resistance were cut out too slowly, the starting resistor could burn up. Since they depended on a person for their correct operation, these motor starters were subject to the problem of human error. They have almost entirely been displaced in new installations by automatic starter circuits.

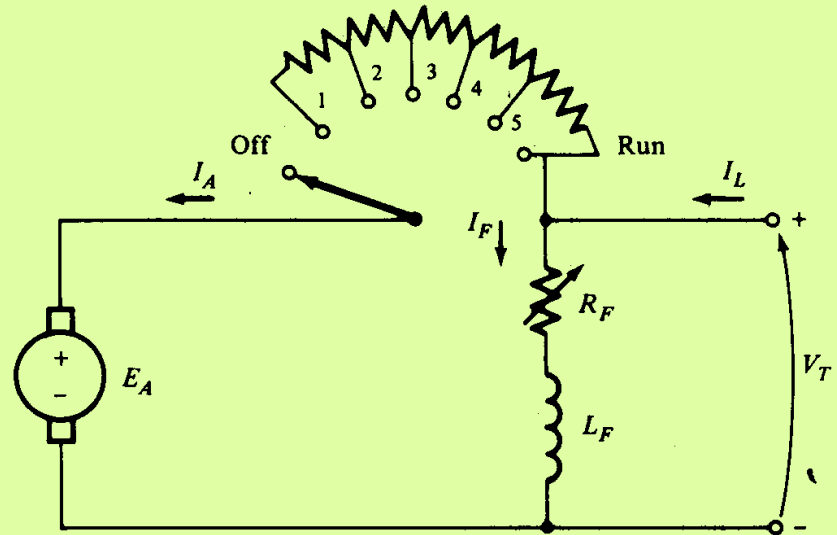
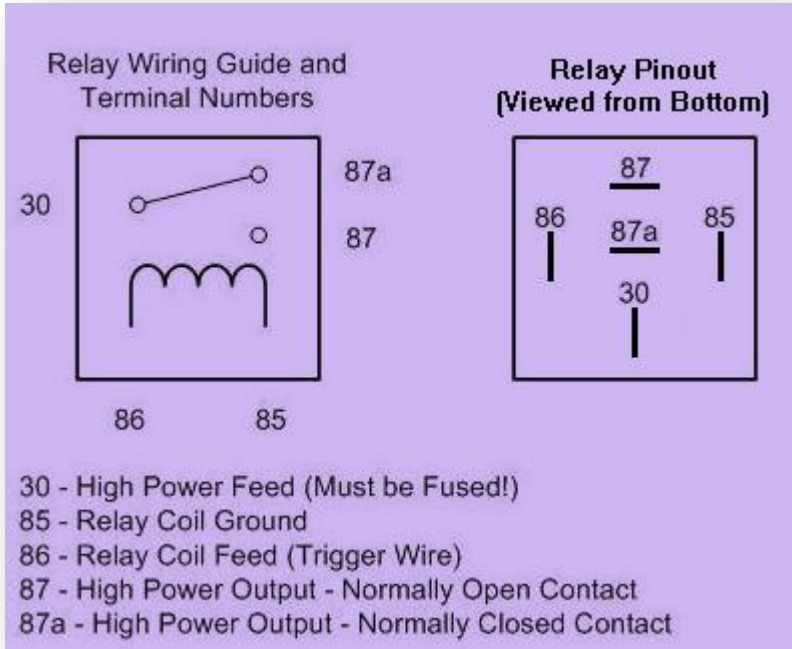

Figure 6-24 A manual dc motor starter.

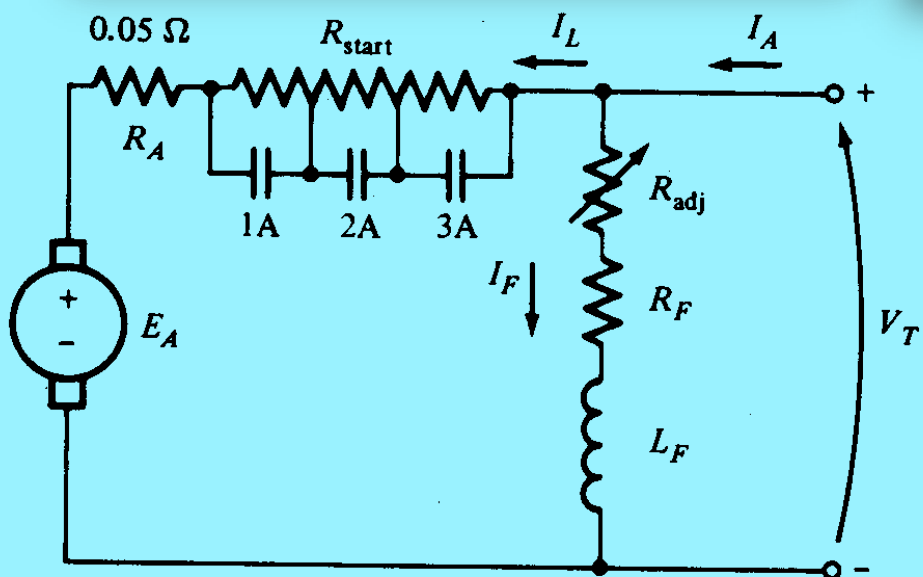
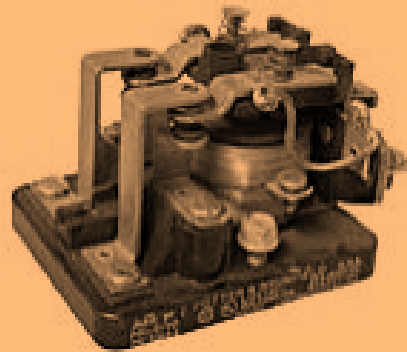

Figure 6-23 A shunt motor with a starting resistor in series with its armature. Contacts 1A, 2A, and 3A short out portions of the starting resistor when they close.

Medium Contactor Relay
24 vdc / DPDT / 25 amp



(KO) PR11DY0

Potter & Brumfield medium contactor relay. DPDT, 25 amp, 240v contacts. 24 vdc coil. 2-1/2" x 3-3/8" x 2-3/8"H.

Contactor Relay
220 vac / 4 Pole / 30 amp

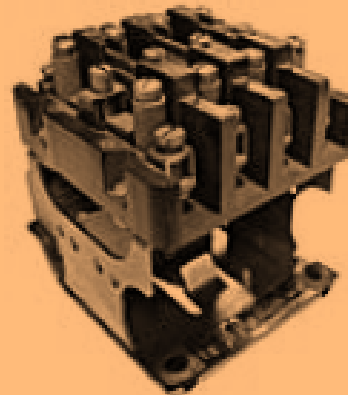

(KO) 105140

RBM contactor relay. 4 pole. 3 poles normally open, 1 pole normally closed. 220 vac, 30 amps. 2-3/4" x 3-1/2" x 3-1/4"H. Harris P/N: 992-1392-001.

Example 6-7 illustrates the selection of the type and number of resistor segments needed by an automatic starter circuit. The question of the timing required to cut the resistor segments out of the armature circuit will be examined later.

Example 6-7 Figure 6-23 shows a 100-hp 250-V 350-A shunt dc motor with an armature resistance of 0.05Ω . It is desired to design a starter circuit for this motor which will limit the maximum starting current to *twice* its rated value and which will switch out sections of resistance as the armature current falls to its rated value.

- (a) How many stages of starting resistance will be required in order to limit the current to the range specified?
- (b) What must the value of each segment of the resistor be? At what voltage should each stage of the starting resistance be cut out?

SOLUTION

(a) To determine the number of stages needed to protect the motor

1. Determine the total resistance $R_{\text{tot}} = R_A + R_{\text{start}}$ needed to limit the current to the desired level when $E_A = 0$.
2. Divide that total resistance by R_A to determine the ratio of the total starting resistance to the normal operating resistance in the motor.

$$\text{SRR} = \frac{R_{\text{tot}}}{R_A} \quad \text{starting resistance ratio} \quad (6-27)$$

3. Determine the ratio of the maximum starting current to the minimum starting current (the starting current ratio, CR) desired in the machine.
4. Divide the starting resistance ratio by the starting current ratio. The number of *whole times* the starting resistance ratio may be divided by the starting current ratio will equal the number of stages required.

In this example problem, the maximum resistance R_{tot} required in the motor is the resistance necessary to limit current flow to 700 A when $E_A = 0$ V. Therefore, the maximum resistance must be

$$\begin{aligned} R_{\text{tot}} &= \frac{V_T}{I_{\text{max}}} \\ &= \frac{250 \text{ V}}{700 \text{ A}} = 0.357 \Omega \end{aligned}$$

How many steps are required to accomplish the current limiting? To find out, define R_{tot} as the original resistance in the starting circuit. So R_{tot} is the sum of the resistance of each stage of the starting resistor together with the resistance of the armature circuit of the motor:

$$R_{\text{tot}} = R_1 + R_2 + \dots + R_A \quad (9-29)$$

Now define $R_{\text{tot},i}$ as the total resistance left in the starting circuit after stages 1 to i have been shorted out. The resistance left in the circuit after removing stages 1 through i is

$$R_{\text{tot},i} = R_{i+1} + \dots + R_A \quad (9-30)$$

Note also that the initial starting resistance must be

$$R_{\text{tot}} = \frac{V_T}{I_{\text{max}}}$$

In the first stage of the starter circuit, resistance R_1 must be switched out of the circuit when the current I_A falls to

$$I_A = \frac{V_T - E_A}{R_{\text{tot}}} = I_{\text{min}}$$

After switching that part of the resistance out, the armature current must jump to

$$I_A = \frac{V_T - E_A}{R_{\text{tot},1}} = I_{\text{max}}$$

Since $E_A (= K\phi\omega)$ is directly proportional to the speed of the motor, which cannot change instantaneously, the quantity $V_T - E_A$ must be constant at the instant the resistance is switched out. Therefore,

$$I_{\text{min}}R_{\text{tot}} = V_T - E_A = I_{\text{max}}R_{\text{tot},1}$$

or the resistance left in the circuit after the first stage is switched out is

$$R_{\text{tot},1} = \frac{I_{\text{min}}}{I_{\text{max}}} R_{\text{tot}} \quad (9-31)$$

By direct extension, the resistance left in the circuit after the n th stage is switched out is

$$R_{\text{tot},n} = \left(\frac{I_{\text{min}}}{I_{\text{max}}}\right)^n R_{\text{tot}} \quad (9-32)$$

The starting process is completed when $R_{\text{tot},n}$ for stage n is less than or equal to the internal armature resistance R_A of the motor. At that point, R_A can limit the current to the desired value all by itself. At the boundary where $R_A = R_{\text{tot},n}$

$$R_A = R_{\text{tot},n} = \left(\frac{I_{\text{min}}}{I_{\text{max}}} \right)^n R_{\text{tot}} \quad (9-33)$$

$$\frac{R_A}{R_{\text{tot}}} = \left(\frac{I_{\text{min}}}{I_{\text{max}}} \right)^n \quad (9-34)$$

Solving for n yields

$$n = \frac{\log (R_A/R_{\text{tot}})}{\log (I_{\text{min}}/I_{\text{max}})} \quad (9-35)$$

where n must be rounded up to the next integer value, since it is not possible to have a fractional number of starting stages. If n has a fractional part, then when the final stage of starting resistance is removed, the armature current of the motor will jump up to a value smaller than I_{max} .

the final stage of starting resistance is removed, the armature current of the motor will jump up to a value smaller than I_{max} . If n has a fractional part, then when the final stage of starting resistance is removed, the armature current of the motor will jump up to a value smaller than I_{max} .

In this particular problem, the ratio $I_{\min}/I_{\max} = 0.5$, and R_{tot} is

$$R_{\text{tot}} = \frac{V_T}{I_{\max}} = \frac{250 \text{ V}}{700 \text{ A}} = 0.357 \Omega$$

so

$$n = \frac{\log (R_A/R_{\text{tot}})}{\log (I_{\min}/I_{\max})} = \frac{\log (0.05 \Omega/0.357 \Omega)}{\log (350 \text{ A}/700 \text{ A})} = 2.84$$

The number of stages required will be three.

Thus *three* stages of starting resistance would be needed in this circuit. Note that this entire process could have been done with a single equation:

$$n = \frac{R_{\text{tot}} \text{ (lowest desired starting current)}}{R_A \text{ (highest desired starting current)}}$$

(b) The armature circuit will contain the armature resistor R_A and three starting resistors R_1 , R_2 , and R_3 . This arrangement is shown in Fig. 6-23.

At first, $E_A = 0 \text{ V}$ and $I_A = 700 \text{ A}$, so

$$I_A = \frac{V_T}{R_A + R_1 + R_2 + R_3} = 700 \text{ A}$$

Therefore, the total resistance must be

$$R_A + R_1 + R_2 + R_3 = \frac{250 \text{ V}}{700 \text{ A}} = 0.357 \Omega \quad (6-28)$$

This total resistance will be placed in the circuit until the current falls to 350 A. This occurs when

$$\begin{aligned} E_A &= V_T - I_A R_{\text{tot}} \\ &= 250 \text{ V} - (350 \text{ A})(0.357 \Omega) = 125 \text{ V} \end{aligned}$$

When $E_A = 125 \text{ V}$, I_A has fallen to 350 A, and it is time to cut out the first starting resistor R_1 . When it is cut out, the current should jump back to 700 A. Therefore,

$$R_A + R_2 + R_3 = \frac{V_T - E_A}{I_{A, \max}} = \frac{250 \text{ V} - 125 \text{ V}}{700 \text{ A}} = 0.1786 \Omega \quad (6-29)$$

This total resistance will be in the circuit until I_A again falls to 350 A. This occurs when E_A reaches

$$\begin{aligned} E_A &= V_T - I_A R_{\text{tot}} \\ &= 250 \text{ V} - (350 \text{ A})(0.1786 \Omega) = 187.5 \text{ V} \end{aligned}$$

When $E_A = 187.5 \text{ V}$, I_A has fallen to 350 A, and it is time to cut out the second starting resistor R_2 . When it is cut out, the current should jump back to 700 A. Therefore,

$$R_A + R_3 = \frac{V_T - E_A}{I_{A, \max}} = \frac{250 \text{ V} - 187.5 \text{ V}}{700 \text{ A}} = 0.0893 \Omega \quad (6-30)$$

Figure 6-24 A manual dc motor starter.

This total resistance will be in the circuit until I_A again falls to 350 A. This occurs when E_A reaches

$$\begin{aligned} E_A &= V_T - I_A R_{\text{tot}} \\ &= 250 \text{ V} - (350 \text{ A})(0.0893 \Omega) = 218.75 \text{ V} \end{aligned}$$

When $E_A = 218.75 \text{ V}$, I_A has fallen to 350 A, and it is time to cut out the third starting resistor R_3 . When it is cut out, only the internal resistance of the motor is left. By now, though, R_A alone can limit the motor's current to

$$\begin{aligned} I_A &= \frac{V_T - E_A}{R_A} = \frac{250 \text{ V} - 218.75 \text{ V}}{0.05 \Omega} \\ &= 625 \text{ A} \quad (\text{less than the allowed maximum}) \end{aligned}$$

From this point on, the motor can speed up by itself.

From Eqs. (6-28) to (6-30), the required resistor values can be calculated. They are

$$R_3 = 0.0893 \, \Omega - 0.05 \, \Omega = 0.0393 \, \Omega$$

$$R_2 = 0.1786 \, \Omega - 0.0393 \, \Omega - 0.05 \, \Omega = 0.0893 \, \Omega$$

$$R_1 = 0.357 \, \Omega - 0.0893 \, \Omega - 0.0393 \, \Omega - 0.05 \, \Omega = 0.178 \, \Omega$$

And R_1 , R_2 , and R_3 are cut out when E_A reaches 125, 187.5, and 218.75 V, respectively. ●

DC Motor Starting Circuits

Once the starting resistances have been selected, how can their shorting contacts be controlled to ensure that they shut at exactly the correct moment? Several different schemes are used to accomplish this switching, and two of the most

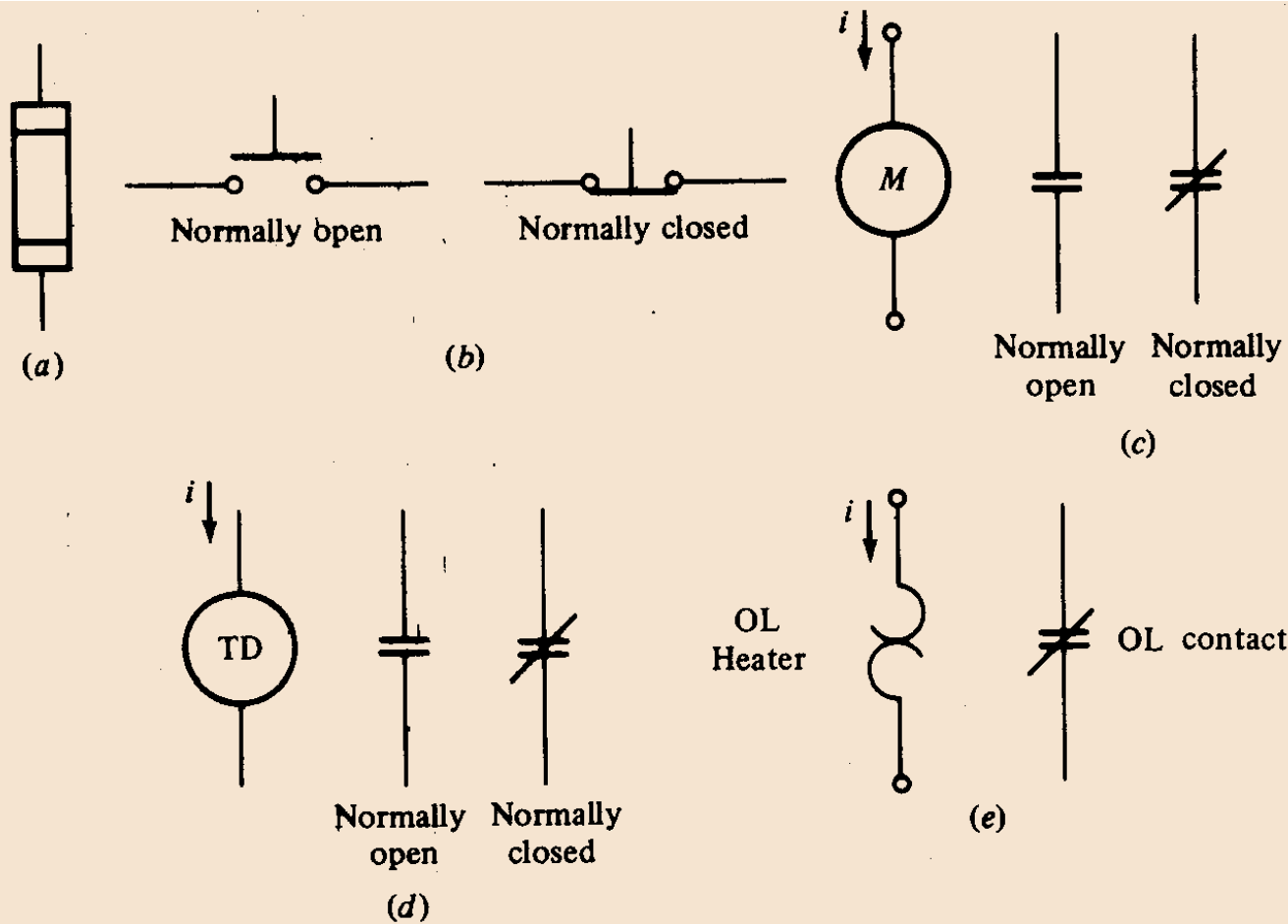

Figure 6-25 (a) A fuse. (b) Normally open and normally closed pushbutton switches. (c) A relay coil and contacts. (d) A time delay relay and contacts. (e) An overload and its normally closed contacts.

common approaches will be examined in this section. Before that is done, though, it is necessary to introduce some of the components used in motor-starting circuits.

Figure 6-25 illustrates some of the devices commonly used in motor-control circuits. The devices illustrated are fuses, pushbutton switches, relays, time delay relays, and overloads.

Figure 6-25 illustrates some of the devices commonly used in motor-control circuits. The devices illustrated are fuses, pushbutton switches, relays, time delay relays, and overloads.

Figure 6-25a shows a symbol for a fuse. The fuses in a motor-control circuit serve to protect the motor against the danger of short circuits. They are placed in the power supply lines leading to motors. If a motor develops a short circuit, the fuses in the line leading to it will burn out, opening the circuit before any damage has been done to the motor itself.

Figure 6-25b shows spring-type pushbutton switches. There are two basic types of such switches—normally open and normally shut. *Normally open* contacts are open when the button is resting and closed when the button has been pushed, while *normally closed* contacts are closed when the button is resting and open when the button has been pushed.

A relay is shown in Fig. 6-25c. It consists of a main coil and a number of contacts. The main coil is symbolized by a circle, and the contacts are shown as parallel lines. The contacts are of two types—normally open and normally closed. A *normally open* contact is one which is open when the relay is deenergized, and a *normally closed* contact is one which is closed when the relay is deenergized. When electric power is applied to the relay (the relay is energized), its contacts change state: The normally open contacts close, and the normally closed contacts open.

322 ELECTRIC MACHINERY FUNDAMENTALS

A time delay relay is shown in Fig. 6-25*d*. It behaves exactly like an ordinary relay except that, when it is energized, there is an adjustable time delay before its contacts change state.

An overload is shown in Fig. 6-25*e*. It consists of a heater coil and some normally shut contacts. The current flowing to a motor passes through the heater coils. If the load on a motor becomes too large, then the current flowing to the motor will heat up the heater coils, which will cause the normally shut contacts of the overload to open. These contacts can in turn activate some type of motor protection circuitry.

One common motor-starting circuit using these components is shown in Fig. 6-26. In this circuit, a series of time delay relays shut contacts which remove

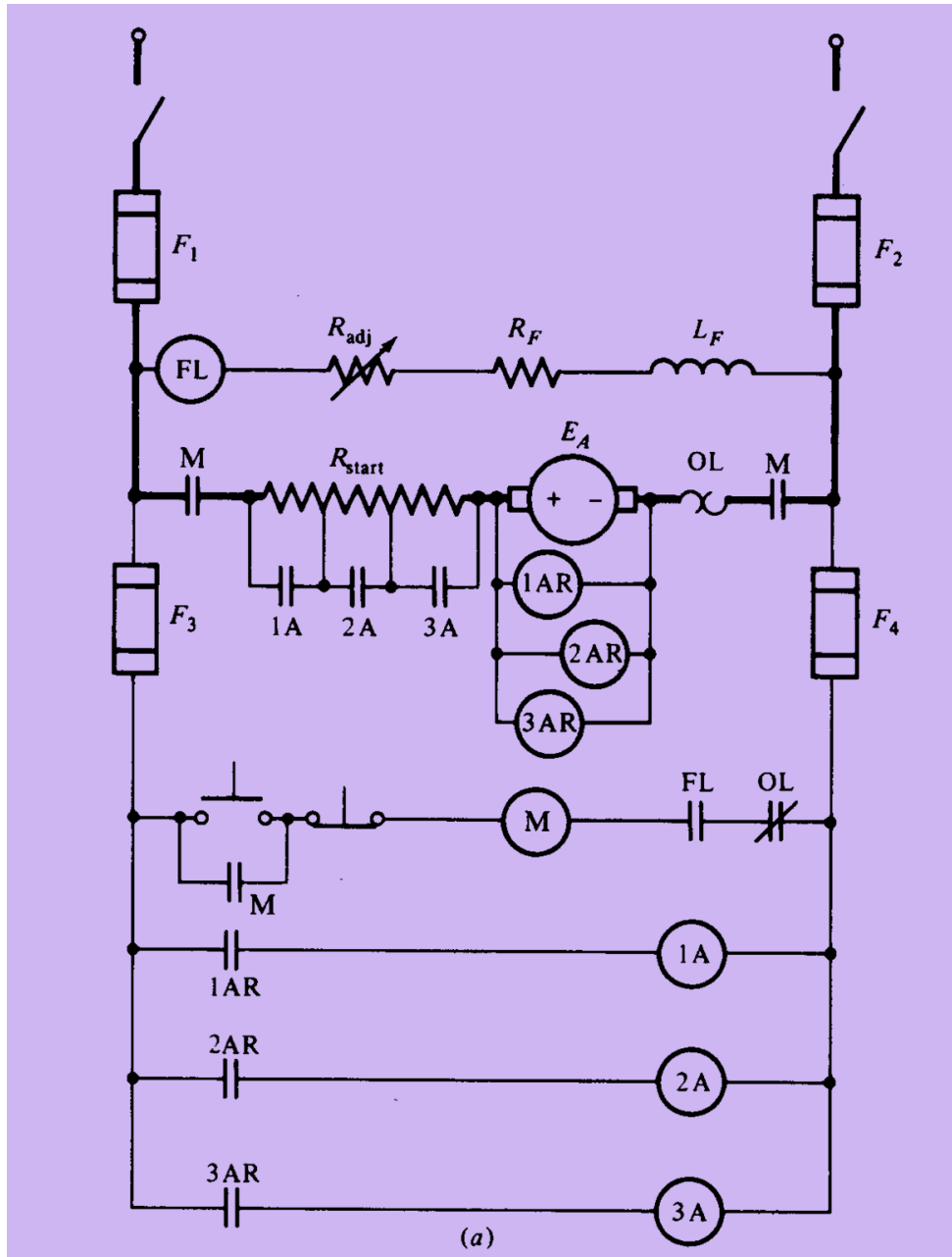

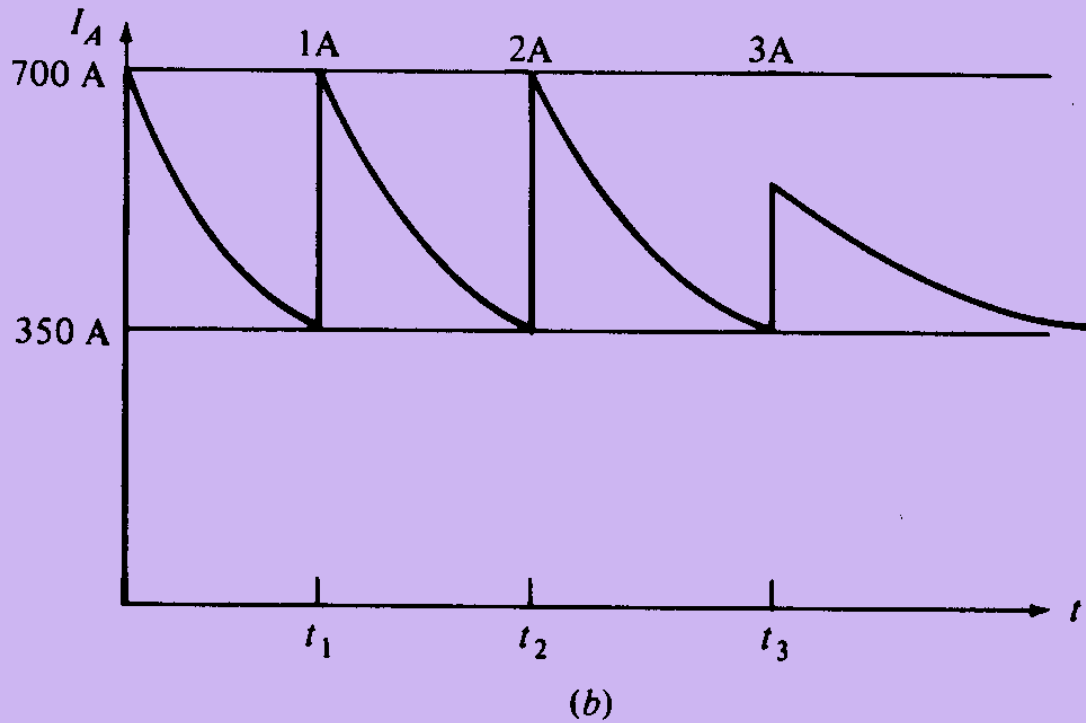

Figure 6-27 (a) A dc motor starting circuit using countervoltage sensing relays to cut out the starting resistor. (b) The armature current in a dc motor during starting.

324 ELECTRIC MACHINERY FUNDAMENTALS

each section of the starting resistor at approximately the correct time after power is applied to the motor. When the start button is pushed in this circuit, the motor's armature circuit is connected to its power supply, and the machine starts with all resistance in the circuit. However, relay 1TD energizes at the same time as the motor starts, so after some delay the 1TD contacts will shut and remove part of the starting resistance from the circuit. Simultaneously, relay 2TD is energized, so after another time delay the 2TD contacts will shut and remove the second part of the timing resistor. When the 2TD contacts shut, the 3TD relay is energized, so the process repeats again, and finally the motor runs at full speed with no starting resistance present in its circuit. If the time delays are picked properly, the starting resistors can be cut out at just the right times to limit the motor's current to its design values.

Another type of motor starter is shown in Fig. 6-27. Here, a series of relays sense the value of E_A in the motor and cut out the starting resistance as E_A rises to preset levels. This type of starter is better than the previous one, since if the motor is loaded heavily and starts more slowly than normal, its armature resistance is still cut out when its current falls to the proper value.

Notice that both starter circuits have a relay in the field circuit labeled FL. This is a *field loss relay*. If the field current is lost for any reason, the field loss relay is deenergized, which turns off power to the M relay. When the M relay deenergizes, its normally open contacts open and disconnect the motor from the power supply. This relay prevents the motor from running away if its field current is lost.

Notice also that there is an overload in each motor-starter circuit. If the power drawn from the motor becomes excessive, these overloads will heat up and open the OL normally shut contacts, thus turning off the M relay. When the M relay deenergizes, its normally open contacts open and disconnect the motor from the power supply, so the motor is protected against damage due to prolonged excessive loads.

